



Battery Specification

Document Number

DS008

Description

Rechargeable Smart Nickel Metal Hydride Battery Pack

Inspired Energy Part Number

NI1030CT

Statement Of Confidentiality

The information contained within this document is confidential and proprietary to Inspired Energy, Inc. This information should not, in whole or in part, be reproduced, disclosed or used except as expressly and duly authorized by Inspired Energy, Inc.



Specification Number	DS008
Specification Revision	2.3
Prepared By	DCB
Issue date	March 28 2012

Battery Specification

TABLE OF CONTENTS

1	REVISION HISTORY	3
2	INTRODUCTION	3
2.1	SCOPE.....	3
2.2	BATTERY PACK OVERVIEW	4
2.3	GENERAL PRECAUTIONS.....	4
2.3.1	Handling	4
2.3.2	Charge & Discharge.....	4
2.3.3	Storage.....	4
2.3.4	Disposal.....	5
3	REQUIREMENTS.....	5
3.1	GENERAL REQUIREMENTS	5
3.1.1	Nominal Voltage	5
3.1.2	Rated Capacity.....	5
3.1.3	Discharge.....	5
3.1.4	Charge	5
3.1.5	Storage.....	6
3.1.6	Terminal Specifications	6
3.2	FUEL-GAUGE ELECTRONICS	6
3.2.1	Overview Of Operation.....	6
3.2.2	7
3.2.3	DC Specifications	7
3.2.4	Measurement Accuracy.....	8
3.2.4.1	Voltage.....	8
3.2.4.2	Temperature	8
3.2.4.3	Current	8
3.2.5	Capacity Display Indicators	8
3.3	SMBUS AND SBD PARAMETERS	9
3.3.1	Overview Of Operations	9
3.3.2	SMBus Logic Levels.....	9
3.3.3	Communication Protocol.....	9
3.3.4	Initialization Procedure.....	9
3.3.4.1	Write Word	9
3.3.4.2	Read Word.....	10
3.3.4.3	Block Read.....	10
3.3.5	Communicating with the Host.....	10
3.3.6	Host To Battery Message (Slave Mode).....	11
3.3.7	Battery To Charger Messages (Master Mode).....	12
3.3.8	Critical Messages (Master Mode).....	12
3.3.9	Definition Of Valid Calibration Cycle	13
3.4	PASSIVE SAFETY PROTECTION.....	14
3.4.1	Overview Of Operations	14
3.4.2	Thermal Fuse	14
3.4.3	PolySwitch	14

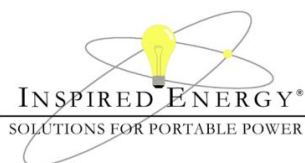

Specification Number	DS008
Specification Revision	2.3
Prepared By	DCB
Issue date	March 28 2012

Battery Specification

3.4.4	Thermostat	14
3.5	MECHANICAL SPECIFICATIONS	14
3.5.1	Battery Weight	14
3.5.2	Mating Connector.....	14
3.5.3	Date Code	14
3.5.4	Packaging	14
3.5.5	Mechanical Drawing	15
3.6	ENVIRONMENTAL/SAFETY SPECIFICATIONS	17
3.6.1	EMC And Safety.....	17
3.7	RELIABILITY	17
3.7.1	Life Expectancy.....	17
3.7.2	Warranty.....	17
3.7.3	Shelf Life	17

1 REVISION HISTORY

Revision	Release Date	Revisions	Issued By
1.0	1/24/03	Released Spec.	R. Hudson
2.0	5/9/03	Clerical corrections.	R. Hudson
2.1	12/6/06	Corrected Current accuracy & guardband for on-board shunt configuration.	R. Hudson
2.2	3/13/09	Corrected mechanical drawing back to the specification originally included in rev 1.0	D.Baggaley
2.3	3/28/12	Deleted the UR & changed to CT	D.Baggaley

2 INTRODUCTION

2.1 Scope

This specification describes the physical, functional and electrical characteristics of a rechargeable Nickel Metal Hydride battery pack supplied by Inspired Energy. This specification is the interface document between Inspired Energy and it's customers. It is understood that customers may create their own internal specification. However, this specification is the master that defines the batteries operation. Battery packs will be built to this specification.



Specification Number	DS008
Specification Revision	2.3
Prepared By	DCB
Issue date	March 28 2012

Battery Specification

2.2 Battery Pack Overview

This specification describes the physical, functional and electrical requirements for the NI1030CT Smart Battery including a rechargeable Nickel Metal Hydride battery and a Battery Management Module. The battery consists of (9) Nickel Metal Hydride rechargeable cells of 4/3A size, assembled in a 9 series configuration. Each cell has an average voltage of 1.2V and a typical capacity of 3850mAh giving a battery pack of 10.8V and 3850mAh typical.

The battery is capable of communicating with host or the charger through the System Management Bus (SMBus). The battery is fully SMBus and SBDS Revision 1.0 compliant. Passive safety devices have been integrated into the pack to protect against over-current and over-temperature.

The battery pack comprises the individual elements as shown below.

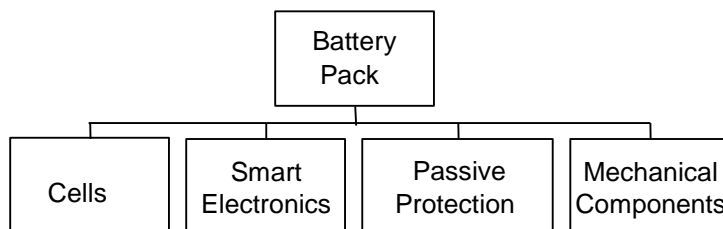

2.3 General Precautions

2.3.1 Handling

- Avoid shorting the battery
- Do not immerse in water.
- Do not disassemble or deform the battery
- Do not expose to, or dispose of the battery in fire.
- Avoid excessive physical shock or vibration.
- Keep out of the reach of children.
- Never use a battery that appears to have suffered abuse.

2.3.2 Charge & Discharge

- Battery must be charged in appropriate charger only.
- Never use a modified or damaged charger.
- Specified product use only.

2.3.3 Storage

- Store in a cool, dry and well-ventilated area.



Specification Number	DS008
Specification Revision	2.3
Prepared By	DCB
Issue date	March 28 2012

Battery Specification

2.3.4 Disposal

- Regulations vary for different countries. Dispose of in accordance with local regulations.

3 REQUIREMENTS

3.1 General Requirements

3.1.1 Nominal Voltage

The battery nominal operating voltage is 10.8V.

3.1.2 Rated Capacity

A fully charged battery shall be discharged at 23°C, at the specified rate until the battery terminal voltage reaches 9.0 volts or as otherwise specified.

- Typical Discharge Capacity at 0.2C Rate: 3850mAh.
- Minimum Discharge Capacity at 0.2C Rate: 3500mAh.
- Minimum Discharge Capacity at 3A Rate: 3000mAh (1V/cell discharge cutoff).

3.1.3 Discharge

The battery shall be capable of continuous discharge from 0°C to +50°C at 3A rate.

- Maximum Continuous discharge current: 3A
- Maximum momentary discharge current, 1s @20°C: 20A

Host devices should be designed for a controlled shutdown following battery notification of termination by the battery sending TERMINATE_DISCHARGE alarm.

The FULLY_DISCHARGED bit in the BatteryStatus() will be set when the battery voltage drops below 9.45V.

3.1.4 Charge

Charge Temperature Limits: -15°C to +0°C at C/10 rate.
+0°C to +40°C at 3A rate.

The NI1030CT is an SMBus compliant smart battery and will handle it's own charging by requesting the proper charge voltage and charger current. It is therefore recommended that the NI1030CT only be charged with an SMBus compliant smart charger rated Level II or Level III.

If a Non-SMBus charger is to be used, it should be set to provide the following regime:

- Minimum 150 mA for 36 – 48 hours.
- Maximum 3000mA until termination by : dT/ dt (1.3°C / min.) or -dV (- 50mV).

The FULLY_CHARGED bit in the BatteryStatus() will be set when charging is complete.

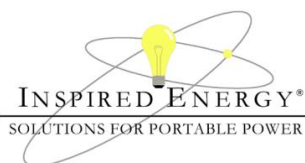

Specification Number	DS008
Specification Revision	2.3
Prepared By	DCB
Issue date	March 28 2012

Battery Specification

3.1.5 Storage

- Storage Temperature Limits: -20°C to +50°C.
- Operational Humidity Limit: <80%

The battery packs should be stored in an environment with low humidity, free from corrosive gas at a recommended temperature range <21°C. Extended exposure to temperatures above 45°C could degrade battery performance and life.

3.1.6 Terminal Specifications

The SMBus Clock and data lines require separate pull-ups to system logic voltage, NOT the battery voltage. Typically a 15KΩ pull-up resistor is used. Please refer to the SMBus Specification for additional information. A key slot is present on each pack for mechanical alignment adjacent to the positive terminal.

Terminal	Legend	Description
1	(+)	Positive side of battery
2	(C)	SMBus Clock.
3	(D)	SMBus Data.
4	(T)	NTC Thermistor Pin (typically 10kΩ at 25°C with the thermistor referenced to the battery negative)
5	(-)	Negative Side Of Battery

3.2 Fuel-Gauge Electronics

3.2.1 Overview Of Operation

The battery is capable of communicating with host or the charger through the System Management Bus (SMBus). The battery is fully SMBus and SBDS Revision 1.0 compliant. An 8-bit Reduced Instruction Set CPU (RISC) is used to process the core algorithms and perform operations required for battery monitoring. Charge and discharge current, cell and pack voltages, and pack temperature are all measured using an integrated analog to digital converter at 12-bit to 14-bit effective resolution depending on the measurement.

The battery pack uses a system level approach to optimize the performance of the battery. Its primary functions are to provide fuel gauging and software based charge control, and to ensure safe operation throughout the life cycle of the battery.

The fuel gauge determines the State-Of-Charge (SOC) by integrating the input and output current of the attached battery. To achieve the desired fuel-gauging accuracy, compensation factors are continually applied to account for battery non-linearity and environmental conditions. This approach provides the user a meaningful and repeatable capacity measure with minimal risk of overstating run time. Visually, the SOC can be obtained from the four on-pack LED's with push-button activation.

Charge control is used to provide optimal and safe charging requests to an SMBus II or level III charger.



Specification Number	DS008
Specification Revision	2.3
Prepared By	DCB
Issue date	March 28 2012

Battery Specification

The system has three modes of operation; active, standby and shutdown. Standby is entered when the system senses no host or charger present for at least 10 seconds. While in standby, battery parameters continue to be monitored at regular intervals to compensate for self-discharge capacity losses. The system will continue in this mode until it senses host activity (communications or current flow). Shutdown mode occurs when the battery voltage falls below 5.5V. In this mode parasitic current is reduced to a minimum by shutting down the micro-controller and all associated circuitry. If this occurs, the battery will require an initial low current charge (as defined in the SMBus Smart Charger Specification) to bring the battery voltage back up before normal operation will resume.

The battery pack block diagram is shown below.

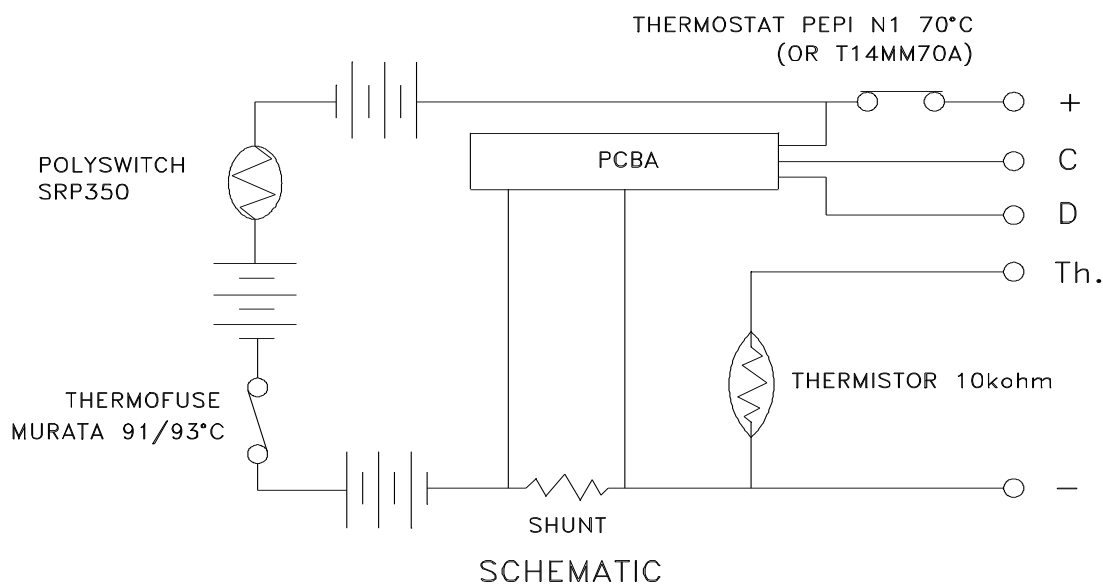

3.2.2

3.2.3 DC Specifications

Parameter	Limits	Remarks
Maximum input voltage	16.2V	
Active mode current consumption	<1.5mA	When a host is detected (charging, discharging or communications).
Standby mode current consumption	<200uA	When no host activity is detected.
Shut-down mode current consumption	<10uA	Battery voltage falls below 5.5V±2.4%. Normal operation resumes when the battery voltage returns to a level 2% to 8% above the shutdown level

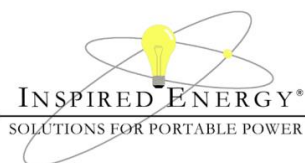

Specification Number	DS008
Specification Revision	2.3
Prepared By	DCB
Issue date	March 28 2012

Battery Specification

3.2.4 Measurement Accuracy

3.2.4.1 Voltage

The voltage measurements have a resolution of 1mV. The absolute accuracy of the reading is $\pm 2\%$ over the operating range. Note that measurements are made at the cell stack (not the pack connector). Therefore internal resistance drops due to the shunt, safety components, and contact resistance are not taken into consideration.

3.2.4.2 Temperature

The internal pack temperature is measured by an on-chip temperature sensor in thermal contact with the cell stack. Temperature readings have a resolution of 0.1°K. The absolute accuracy is $\pm 3^\circ\text{K}$ over an operating range of 0°C to +50°C.

3.2.4.3 Current

The current measurements have a resolution of 1mA. The absolute accuracy of the reading is $\pm 2.0\%$ or $\pm 8\text{mA}$ whichever is greater over the operating range. A guard band has been imposed around zero current (-15mA to +15mA).

3.2.5 Capacity Display Indicators

Pressing on the “PUSH” panel on the battery pack will result in the LED indications as shown below:

*Capacity	LED indicators #				Notes
	1	2	3	4	
On or below 10%					Blinks 3 times.
10% - 25%					Lit for 5 seconds.
26% - 50%					Lit for 5 seconds.
51% - 75%					Lit for 5 seconds.
76% - 100%					Lit for 5 seconds.

* Note: These values represent the relative state of charge of the battery. If the battery voltage is below 5.8Vdc, there will be no LED indication.



Specification Number	DS008
Specification Revision	2.3
Prepared By	DCB
Issue date	March 28 2012

Battery Specification

3.3 SMBus and SBD Parameters

3.3.1 Overview Of Operations

The battery is fitted with a microprocessor and associated circuitry for communication with an external host device and/or smart battery charger. Reference should be made to the following specifications when reading this section:

- System Management Bus Specification (Rev 1.0, Feb 15, 1995)
- Smart Battery Data Specification (Rev 1.0, Feb 15, 1995)
- Smart battery Charger Specification (Rev 0.95a, Feb 15, 1995)

3.3.2 SMBus Logic Levels

Symbol	Parameter	Limits		Units
		Min	Max	
Vil	Data/Clock input low voltage		0.6	V
Vih	Data/Clock input high voltage	1.4	5.5	V
Vol			0.4	V

3.3.3 Communication Protocol

SMBus Interface complies with SBS Specification Version 1.0. The battery pack includes a simple bi-directional serial data interface. A host processor uses the interface to access various battery pack registers.

3.3.4 Initialization Procedure

The interface uses a command-based protocol, where the host processor sends the battery address command byte to the battery pack. The command directs the battery pack to either store the next data received to a register specified command byte or output the data specified by the command byte.

The Bus Host communicates with the battery pack using one of three protocols:

- Write Word
- Read Word
- Read Block

3.3.4.1 Write Word

The first byte of a Write Word access is the command code. The next two Bytes are the data to be written. In this example the master asserts the slave device address followed by the write bit. The device acknowledges and the master delivers the command code. The slave again acknowledges before the master sends the data word (low byte first). The slave acknowledges each byte according to the I²C specification, and the entire transaction is finished with a stop condition.

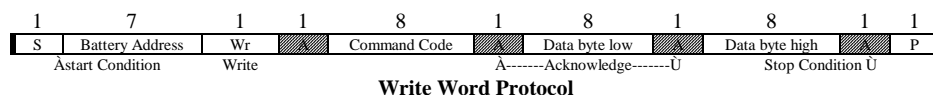



Specification Number	DS008
Specification Revision	2.3
Prepared By	DCB
Issue date	March 28 2012

Battery Specification



3.3.4.2 Read Word

Reading data is slightly more complex than writing data. First the host must write a command to the slave device. Then it must follow that command with a repeated start condition to denote a read from that device's address. The slave then returns two bytes of data.

Note that there is not a stop condition before the repeated start condition, and that a "Not Acknowledge" signifies the end of the read transfer.

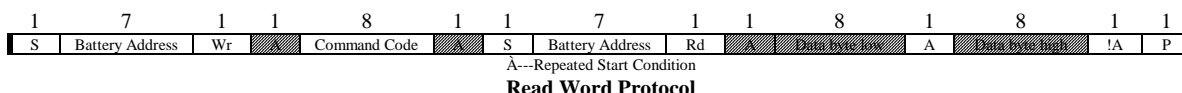

3.3.4.3 Block Read

The Block Read begins with a slave address and a write condition. Then it must follow that command with a repeated start condition to denote a read from that device's address. After the repeated start the slave issues a byte count that describes how many data bytes will follow in the message. If a slave had 20 bytes to send, the first byte would be the number 20 (14h), followed by the 20 bytes of data. The byte count may not be 0. A Block Read can transfer a maximum of 32 bytes.

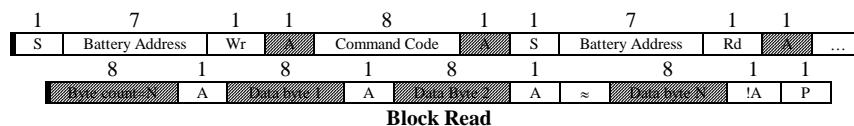

3.3.5 Communicating with the Host

A message destined for the host could appear from an unknown device in an unknown format. To prevent possible confusion on the host part, only one method of communication is allowed -- a modified Write Word. This protocol is used when an SMBus device becomes a master to communicate with the SMBus host acting as a slave.

Device to Host communication will begin with the host address. The message's Command Code will actually be the initiating device's address. The host now knows the origin of the following 16 bits of device status.

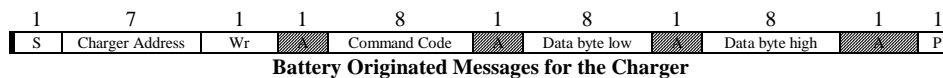

Note : For the detail and the latest information, please refer to the Web Site address : www.sbs-forum.org

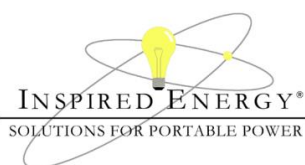

Specification Number	DS008
Specification Revision	2.3
Prepared By	DCB
Issue date	March 28 2012

Battery Specification

3.3.6 Host To Battery Message (Slave Mode)

The Host acting in the role of a bus master, uses the read word, write word, and read block protocols to communicate with the battery, operating in slave mode.

Host-to-Battery Messages

Function	Command Code	Description	Unit	Access	Default (POR)
ManufacturerAccess()	0x00			r/w	
RemainingCapacityAlarm()	0x01	Remaining Capacity Alarm Threshold .	mAh	r/w	385
RemainingTimeAlarm()	0x02	Remaining Time Alarm Threshold.	minutes	r/w	10
BatteryMode()	0x03	Battery Operational Modes.	Bit flags	r/w	0x0080
AtRate()	0x04	This function is the first half of a two-function call-set used to set the AtRate value used in calculations made by the AtRateTimeToFull(), AtRateTimeToEmpty(), and AtRateOK() functions.	mA	r/w	0
AtRateTimeToFull()	0x05	Returns the predicted remaining time to fully charge the battery at the AtRate() value.	minutes	r	65535
AtRateTimeToEmpty()	0x06	Returns the predicted remaining operating time if the battery is discharged at the AtRate() value.	minutes	r	65535
AtRateOK()	0x07	Returns a Boolean value that indicates whether or not the battery can deliver the AtRate value of additional energy for 10 seconds. If the AtRate() value is zero or positive, the AtRateOK() function will ALWAYS return TRUE.	boolean	r	1
Temperature()	0x08	Returns the pack's internal temperature.	0.1 °K	r	
Voltage()	0x09	Returns the battery's voltage (measured at the cell stack)	mV	r	
Current()	0x0a	Returns the current being supplied (or accepted) through the battery's terminals.	mA	r	0
AverageCurrent()	0x0b	Returns a rolling average based upon the last 64 samples of current.	mA	r	0
MaxError()	0x0c	Returns the expected margin of error.	percent	r	10
RelativeStateOfCharge()	0x0d	Returns the predicted remaining battery capacity expressed as a percentage of FullChargeCapacity().	percent	r	0
AbsoluteStateOfCharge()	0x0e	Returns the predicted remaining battery capacity expressed as a percentage of DesignCapacity().	percent	r	0
RemainingCapacity()	0x0f	Returns the predicted remaining battery capacity.	mAh	r	0
FullChargeCapacity()	0x10	Returns the predicted battery capacity when fully charged.	mAh	r	3465
RunTimeToEmpty()	0x11	Returns the predicted remaining battery life at the present rate of discharge.	minutes	r	65535
AverageTimeToEmpty()	0x12	Returns the rolling average of the predicted remaining battery life.	minutes	r	65535
AverageTimeToFull()	0x13	Returns the rolling average of the predicted remaining time until the battery reaches full charge.	minutes	r	65535
ChargingCurrent()	0x14	Returns the battery's desired charging rate.	mA	r	
ChargingVoltage()	0x15	Returns the battery's desired charging voltage.	mV	r	65535
BatteryStatus()	0x16	Returns the battery's status word.	Bit flags	r	0x2C0
CycleCount()	0x17	Returns the number of charge/discharge cycles the battery has experienced. A charge/discharge cycle is defined as "starting from a base value equivalent to the battery's highest SOC reached after the battery is no longer accepting current before the present charge/discharge cycle is complete and ending when the battery starts accepting current and its SOC has decreased by 15% or more from that base value."	cycles	r	0
DesignCapacity()	0x18	Returns the theoretical capacity of the new battery.	mAh	r	3850
DesignVoltage()	0x19	Returns the theoretical voltage of a new battery.	mV	r	10800
SpecificationInfo()	0x1a	Returns the version number of the SBDS the battery pack supports, as well as voltage and current scaling information.	Formatted word	r	0x0010
ManufacturerDate()	0x1b	Returns the date the electronics were manufactured.	Formatted word	r	
SerialNumber()	0x1c	Returns the electronics serial number.	number	r	
Reserved	0x1d			r	
	0x1f				
ManufacturerName()	0x20	Returns a character array containing the manufacture's name.	string	r	INSPIREDE
DeviceName()	0x21	Returns a character array that contains the battery's name.	string	r	NI1030
DeviceChemistry()	0x22	Returns a character array that contains the battery's chemistry.	string	r	NiMH
ManufacturerData()	0x23	Returns data specific to the manufacture.		r	



Specification Number	DS008
Specification Revision	2.3
Prepared By	DCB
Issue date	March 28 2012

Battery Specification

3.3.7 Battery To Charger Messages (Master Mode)

The battery, acting in the role of a bus master, uses the write word protocol to communicate with the charger, operating in slave mode. If the CHARGER_MODE bit in BatteryMode() is clear, the Battery will broadcast Charger request information at 15-second intervals.

Battery-to-Charger Messages

Function	Command Code	Description	Unit	Access
ChargingCurrent()	0x14	Sends the desired charging rate to the battery charger	mA	w
ChargingVoltage()	0x15	Sends the desired charging voltage to the battery charger	mV	w

3.3.8 Critical Messages (Master Mode)

Whenever the Battery detects a critical condition, it takes the role of a bus master and sends AlarmWarning() message to the Host and/ or Charger. The Battery broadcasts the AlarmWarning() message at 10 second intervals until the critical condition(s) has been corrected.

Battery Critical Messages

Function	Command Code	Description	Unit	Access
AlarmWarning()	0x16	This message is to the host and/or charger to notify them that one or more alarm conditions exist.	Formatted word	w

Alarm Bit Definitions

Hex	Battery Status	Status	Definition
4000	TERMINATE_CHARGE_ALARM	ON	Battery is requesting 0 ChargingCurrent() and the charger continues to supply current
		OFF	When either condition is removed.
1000	OVER_TEMP_ALARM	ON	If "Temperature()" >= 52degC.
		OFF	When the "Temperature()" drops below 45°C.
800	TERMINATE_DISCHARGE_ALARM	ON	During discharge when the battery voltage drops below 9.45V
		OFF	Battery Voltage is equal or greater than 9.45V.
200	REMAINING_CAPACITY_ALARM (User settable)	ON	Battery detects that its RemainingCapacity() is less than that set by the RemainingCapacityAlarm()
		OFF	Either the value set by the RemainingCapacityAlarm() is lower than the RemainingCapacity() OR when the RemainingCapacity() increases by charging the battery.
100	REMAINING_TIME_ALARM (User settable)	ON	Battery detects that the estimated remaining time at the present discharge rate is less than that set by the RemainingTimeAlarm()
		OFF	Either the value set by the RemainingTimeAlarm() is lower than the AverageTimeToEmpty() OR when the AverageTimeToEmpty() increases by charging the battery.



Specification Number	DS008
Specification Revision	2.3
Prepared By	DCB
Issue date	March 28 2012

Battery Specification

Status Bit Definitions

80	INITIALIZED	ON	Always
		OFF	
40	DISCHARGING	ON	Battery "Current()" is not positive
		OFF	Battery "Current()" is positive
20	FULLY_CHARGED	ON	Charge terminated by a qualified $\Delta T/\Delta t$, $-\Delta V$, or coulometric termination. ($\Delta T/\Delta t = 1.2\text{degC}/\text{min}$; $-\Delta V = -45\text{mV}$)
		OFF	When the SOC of the battery declines 3% from the "FULLY_CHARGE" detection point.
10	FULLY_DISCHARGED	ON	Microcontroller reset or battery "Voltage()" below 9.45V.
		OFF	Relative State Of Capacity above 20%

Note:

** The host device should initiate a 'Save-To-Disk' action when the battery broadcast the TERMINATE_DISCHARGE Alarm during discharge.

3.3.9 Definition Of Valid Calibration Cycle

Calibration is the process whereby the battery's fuel gauge is adjusted to maintain an acceptable level of accuracy. This may be necessary if a battery has aged or has been subjected to an unusual usage pattern. A battery can be calibrated by performing the following procedure:

1. Discharge the battery until the TERMINATE_DISCHARGE_ALARM in the BatteryStatus() is set (cell stack voltage $\leq 9.45\text{V}$).
2. Charge the battery until the charge termination is achieved and the TERMINATE_CHARGE_ALARM in the BatteryStatus() is set. This will be achieved either by use of an SMBus level II or III charger or by dT/dt ($1.2^\circ\text{C}/\text{min}$.) or $-dV$ (-45mV). Repeat step 1.

Note, Calibration is invalid if:

- Pack Voltage across the battery terminals goes below 7.5V or above 16.0V.
- Pack Temperature goes below 15°C or exceeds 55°C during a calibration cycle.
- Accumulative self-discharge is more than 3% of the FullChargeCapacity().

Notes On Calibration And Maximum Error:

Although Inspired Energy's detailed modeling of cell characteristics ensures that the most accurate correction factors are applied to the fuel gauge capacity to compensate for the effects of time, temperature, usage patterns and charge/discharge rates - it is inevitable that the fuel gauge accuracy will drift with time.

The smart electronics only know the actual capacity at two reference points: 'empty' and 'fully charged'. When either of these two points is reached, the predicted capacity is compared with the known capacity and an error factor is calculated (Max Error). It is recommended that the application software recommend to the user that the battery should be calibrated when a pre-determined max error limit is reached (10% for example).

At the completion of the calibration cycle, the CONDITION_FLAG in the BatteryMode() register will be reset.

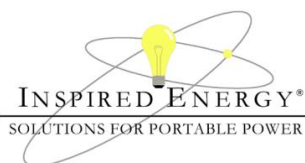

Specification Number	DS008
Specification Revision	2.3
Prepared By	DCB
Issue date	March 28 2012

Battery Specification

3.4 Passive Safety Protection

3.4.1 Overview Of Operations

The battery pack is fitted with additional components to protect it against abusive charge and discharge conditions.

3.4.2 Thermal Fuse

A Thermal Fuse is fitted in series with the charge/ discharge path to protect the battery from over temperature. This device goes open circuit if the cell case temperature reaches the fuse's temperature rating of 93°C (+0°C, -5°C). The fuse is non-re-settable rendering the battery pack non-functional.

3.4.3 PolySwitch

A polyswitch is fitted in series with the charge/discharge path to protect the battery from external short circuit. This is a polymer device, which has a low resistance under normal operating conditions. In the event of an excessive current, the increase in heat causes the device to "Trip" to a high resistance state - reducing the current to a safe level. The device returns to the low resistance state once the short circuit is removed. The maximum holding overload current limit is 3.5A at 20°C and the maximum trip current is 6.3A

3.4.4 Thermostat

A thermostat is assembled in series with the battery pack to prevent current flow in battery if the temperature rises above 70°C (± 5°C). The thermostat is a re-settable safety device and will allow current to flow once the battery has reached an acceptable temperature.

3.5 Mechanical Specifications

3.5.1 Battery Weight

Typical battery weight: 510 grams (± 20 grams).

3.5.2 Mating Connector

The AMP Battery Interconnection system connector is used, which provides polarized mating. The mating AMP connector part number is 787415-1.

3.5.3 Date Code

A date code is stamped on the end of each pack. The format is in the form of 8 digit alphanumeric code

$\overline{ZZ} \overline{YYWW} \overline{BB}$
 Manufacturing site _____ ↑ _____ ↑ _____ Battery Revision
 Manufacturing Date (Calendar Year) _____ ↑

3.5.4 Packaging

The battery is packaged in bulk, with 24 batteries per carton.



Battery Specification

Specification Number	DS008
Specification Revision	2.3
Prepared By	DCB
Issue date	March 28 2012

3.5.5 Mechanical Drawing

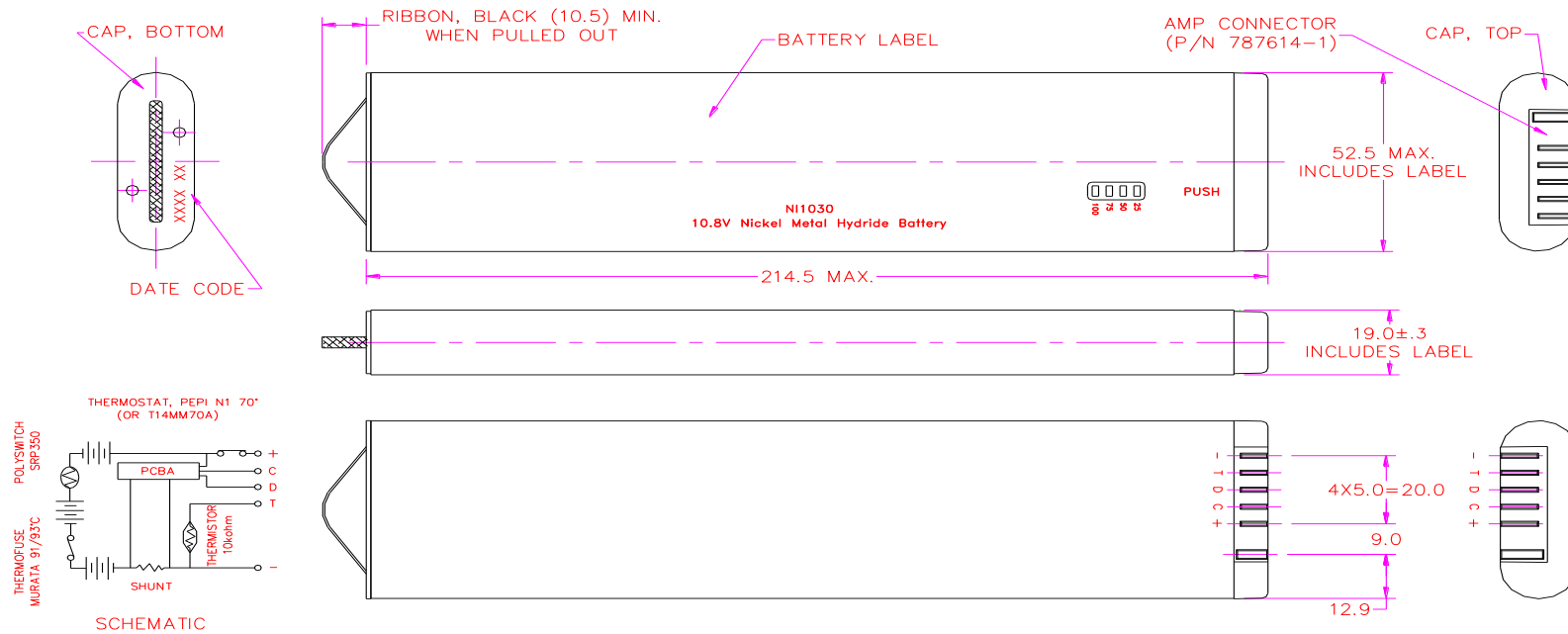



Specification Number	DS008
Specification Revision	2.3
Prepared By	DCB
Issue date	March 28 2012

Battery Specification

3.6 Environmental/Safety Specifications

3.6.1 EMC And Safety

The battery will comply with the following:

- EMC Directive Measures 89/336/EEC
- Low Voltage Directive 73/23/EEC
- Toxic Chemicals Directive 91/157/EEC

The battery carries the following approvals and the pack will be labeled accordingly:

- FCC
- CE

3.7 Reliability

3.7.1 Life Expectancy

The battery will be capable of a minimum of 300 cycles using normal fully charge and fully discharged conditions. The battery will maintain at least 50% of nominal rated capacity after the 300th cycle.

3.7.2 Warranty

A high quality standard is maintained by Inspired Energy. All products are warranted against defects in workmanship, material and construction. The warranty period is one (1) year from the date of shipment from Inspired Energy.

3.7.3 Shelf Life

The batteries are shipped from Inspired Energy with between 30% and 50% rated capacity and this provides a minimum of 3 months shelf life, when stored at 25°C. If the storage temperature exceeds 25°C over the 6-month period then the shelf life will be reduced and provisions should be made to recharge the battery periodically. In order to prevent parasitic drain on the battery, the electronics will go into a shutdown mode at 5.5V. If this should happen, the battery pack will require an initial low charge to activate the electronics prior to the implementation of the normal charge. Any SMBus version 1.0, or higher, compatible charger is capable of providing this initial pre-charge. At this point it is advisable to recalibrate the electronics if the charger does not complete this process automatically.