

Battery Specification

Document Number & Revision

DS421A11

Description

Rechargeable Smart Lithium Ion Battery Pack

Inspired Energy Part Number for Battery

PH2059HD34

Statement of Confidentiality

The information contained within this document is confidential and proprietary to Inspired Energy. This information should not, in whole or in part, be reproduced, disclosed or used except as expressly and duly authorized by Inspired Energy.

This information is descriptive only. No representation, guarantee or warranty of merchantability or fitness for purpose is made or implied. Specifications are subject to change without notice.



Battery Specification

Specification Number	DS421A10
Specification Revision	1.1
Prepared By	JAB
Issue date	1/27/16

TABLE OF CONTENTS

1. REVISION HISTORY	4
2. INTRODUCTION	4
2.1. SCOPE.....	4
2.2. BATTERY PACK OVERVIEW	4
2.3. GENERAL PRECAUTIONS.....	5
2.3.1. Handling.....	5
2.3.2. Charge & Discharge.....	5
2.3.3. Storage.....	5
2.3.4. Disposal.....	5
3. REQUIREMENTS.....	5
3.1. GENERAL REQUIREMENTS	5
3.1.1. Nominal Voltage	5
3.1.2. Rated Capacity.....	5
3.1.3. Initial Impedance.....	6
3.1.4. Discharge.....	6
3.1.5. Charge	7
3.1.6. Storage.....	7
3.1.7. Terminal Specifications	7
3.2. FUEL-GAUGE ELECTRONICS	7
3.2.1. Overview of Operation.....	7
3.2.2. DC Specifications	8
3.2.3. Measurement Accuracy.....	9
3.2.3.1. Voltage.....	9
3.2.3.2. Temperature	9
3.2.3.3. Current	9
3.2.4. LCD Indication	9
3.3. SMBUS AND SBD PARAMETERS	10
3.3.1. Overview Of Operations	10
3.3.2. SMBus Logic Levels.....	10
3.3.3. Communication Protocol.....	10
3.3.4. Initialization Procedure.....	10
3.3.4.1. Write Word	11
3.3.4.2. Read Word	11
3.3.4.3. Block Read.....	11
3.3.5. Communicating with the Host.....	12
3.3.6. Host To Battery Message (Slave Mode).....	12
3.3.7. Battery To Charger Messages (Master Mode).....	14
3.3.8. Critical Messages (Master Mode).....	14
3.3.9. Definition Of Valid Calibration Cycle	15
3.4. PROTECTION ELECTRONICS	16
3.4.1. Overview Of Operation.....	16
3.4.2. Charge Protection	16
3.4.3. Discharge Protection.....	16
3.5. PASSIVE SAFETY PROTECTION.....	17
3.5.1. Overview Of Operation.....	17



Battery Specification

Specification Number	DS421A10
Specification Revision	1.1
Prepared By	JAB
Issue date	1/27/16

3.5.2.	<i>Slow-Blow Current Fuse</i>	17
3.6.	MECHANICAL SPECIFICATIONS	17
3.6.1.	<i>Weight</i>	17
3.6.2.	<i>Mating Connector</i>	17
3.6.3.	<i>Date Code/Serial Number</i>	18
3.6.4.	<i>Packaging</i>	18
3.6.5.	<i>Mechanical Drawing</i>	19
3.7.	ENVIRONMENTAL/SAFETY SPECIFICATIONS.....	20
3.7.1.	<i>EMC And Safety</i>	20
3.8.	RELIABILITY	20
3.8.1.	<i>Life Expectancy</i>	20
3.8.2.	<i>Warranty</i>	20
3.8.3.	<i>Shelf Life</i>	20



Battery Specification

Specification Number	DS421A10
Specification Revision	1.1
Prepared By	JAB
Issue date	1/27/16

1. REVISION HISTORY

Revision	Release Date	Revisions	Issued By	Approved By
1.0	1/7/15	Released	JAB	RAH,DB,LJ
1.1	1/27/16	Changed shipping s-o-c	LJ	LJ

2. INTRODUCTION

2.1. Scope

This specification describes the physical, functional and electrical characteristics of a rechargeable Lithium Ion battery pack supplied by Inspired Energy. This specification is the interface document between Inspired Energy and it's customers. It is understood that customers may create their own internal specification. However, this specification is the master that defines the battery's operation. Battery packs produced will meet this specification.

2.2. Battery Pack Overview

This specification describes the physical, functional and electrical requirements for the PH2059HD34 Smart Battery including a rechargeable Lithium Ion battery and a Battery Management Module. The battery consists of (8)Lithium Ion rechargeable cells of 18650 assembled in a 8 series / 1 parallel (8S 1P) configuration. Each cell has an average voltage of 3.6V and a typical capacity of 3.4Ah giving a battery pack of 28.8V and 3.4Ah typical.

The battery is capable of communicating with host or the charger through the System Management Bus (SMBus). The battery is fully SMBus and SBDS Revision 1.0 compliant. Protection is provided for over-charge, over-discharge and short circuit. For redundancy, passive safety devices have been integrated into the pack to protect against over-current and over-temperature.

The battery pack comprises the individual elements as shown below.

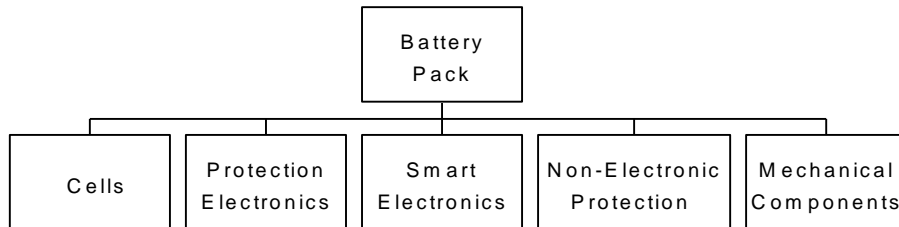



Battery Specification

Specification Number	DS421A10
Specification Revision	1.1
Prepared By	JAB
Issue date	1/27/16

2.3. General Precautions

2.3.1. Handling

- Avoid shorting the battery
- Do not immerse in water.
- Do not disassemble or deform the battery
- Do not dispose of the battery in fire.
- Avoid excessive physical shock or vibration.
- Keep out of the reach of children.
- Never use a battery that appears to have suffered abuse.

2.3.2. Charge & Discharge

- Battery must be charged with an appropriate charger only.
- Never use a modified or damaged charger.
- Specified product use only.

2.3.3. Storage

- Store in a cool, dry and well-ventilated area.
- Do not expose the battery to open flames.

2.3.4. Disposal

- Regulations vary for different countries. Dispose of in accordance with local regulations.

3. REQUIREMENTS

3.1. General Requirements

3.1.1. Nominal Voltage

The battery nominal operating voltage is 28.8V.

3.1.2. Rated Capacity

The initial capacity is $\geq 3230\text{mAh}$ (based on a CV charge of $33.6\text{V} \pm 50\text{mV}$ with a current limit of 1500mA and a 680mA discharge to 20.0V @ 25C, within 1 hour of charge).



Battery Specification

Specification Number	DS421A10
Specification Revision	1.1
Prepared By	JAB
Issue date	1/27/16

3.1.3. Initial Impedance

The internal impedance of a fully charged battery shall be < 600mΩ when measured across the positive and negative battery terminals at 1kHz at 20°C.

3.1.4. Discharge

Discharge Temperature Limits: -10°C to 50°C, ≤ 80%RH

The battery shall be capable of continuous discharge within the Pack Operating Boundary as shown in the graph below.

Host devices should be designed for a controlled shutdown following battery notification of termination by the battery sending TERMINATE_DISCHARGE alarm, prior to protection circuit cut-off.

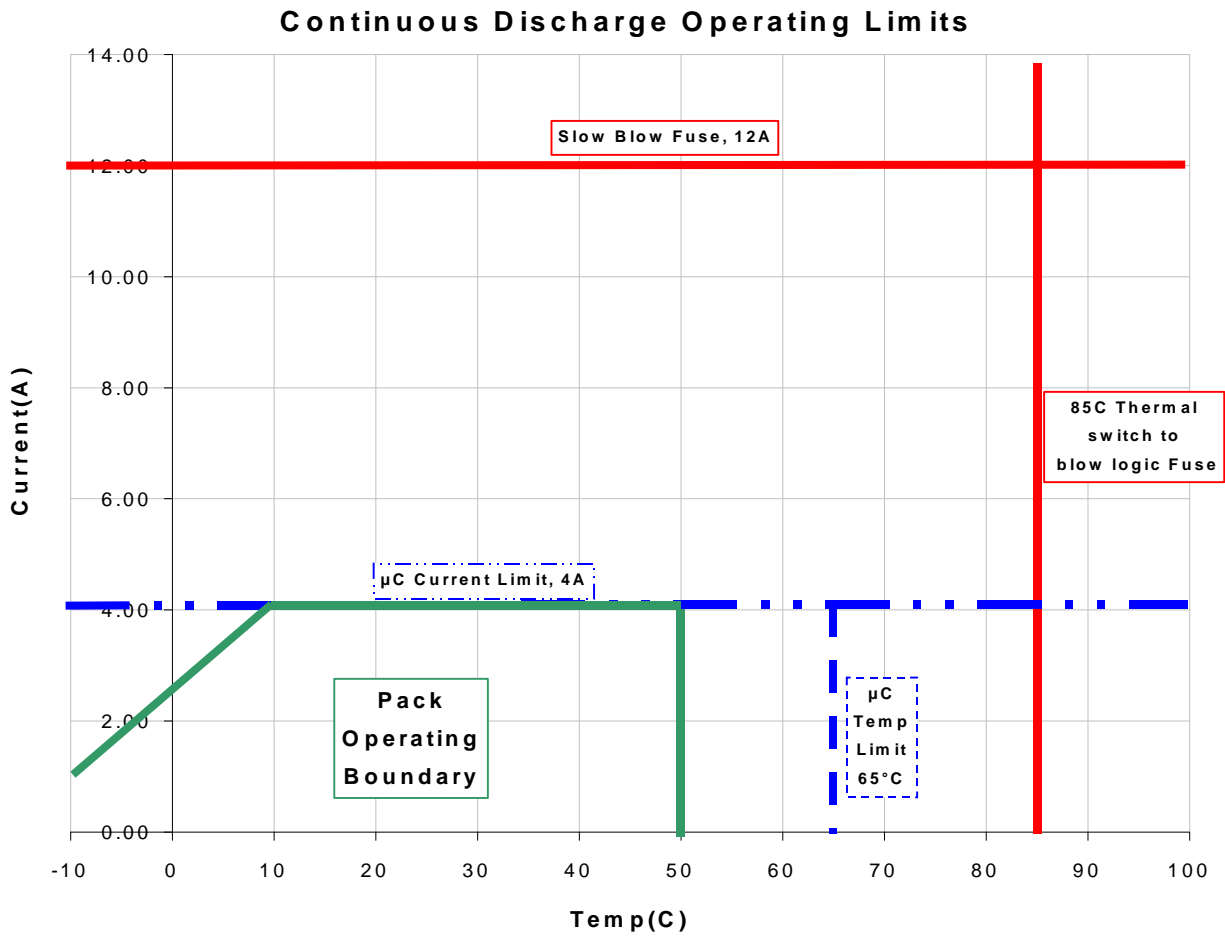



Battery Specification

Specification Number	DS421A10
Specification Revision	1.1
Prepared By	JAB
Issue date	1/27/16

3.1.5. Charge

Charge Temperature Limits: 0°C to 45°C, ≤ 80%RH

The battery shall be capable of continuous charge at 33.6V, 1500mA across the entire charge temperature range. A dedicated level II or level III smart battery charger is required to charge the battery. Using this type of charger, the battery will request appropriate charging Voltage and Current from the smart battery charger.

The FULLY_CHARGED bit in the BatteryStatus() will be set when the charging current tapers down under 103mA while charging at 33.6V.

3.1.6. Storage

Storage Temperature Limits: -20°C to 60°C, ≤ 80%RH

The battery packs should be stored in an environment with low humidity, free from corrosive gas at a recommended temperature range <21°C. Extended exposure to temperatures above 45°C could degrade battery performance and life.

3.1.7. Terminal Specifications

See Mechanical Drawing for orientation of contacts J1-A1, A2, 1-5

Terminal	Legend	Description
A1	(+)	Positive side of battery
2	(C)	SMBus Clock. Internally a 1MΩ resistor is connected between (C) and (-).
3	(D)	SMBus Data. Internally a 1MΩ resistor is connected between (D) and (-).
4	(T)	300Ω ±5% resistor connected between (T) and (-).
A2	(-)	Negative Side Of Battery

- The SMBus Clock and data lines require separate external pull-ups to system logic voltage, NOT the battery voltage. Typically a 15KΩ pull-up resistor is used, but please refer to the SMBus Specification for additional information.

3.2. Fuel-Gauge Electronics

3.2.1. Overview of Operation

The battery is capable of communicating with host or the charger through the System Management Bus (SMBus). The battery is fully SMBus and SBDS Revision 1.0 compliant. An 8-bit Reduced Instruction Set CPU (RISC) is used to process the core algorithms and perform operations required for battery monitoring. Charge and discharge current, cell and pack voltages, and pack temperature are all measured using an integrated analog to digital converter at 12-bit to 14-bit effective resolution depending on the measurement.

Protection circuits for over-charge, over-discharge and short-circuit are also included, as well as passive safety devices for short-circuit and thermal protection.



Battery Specification

Specification Number	DS421A10
Specification Revision	1.1
Prepared By	JAB
Issue date	1/27/16

3.2.3. Measurement Accuracy

3.2.3.1. Voltage

The voltage measurements have a resolution of 1mV. The absolute accuracy of the reading is $\pm 1\%$ over the operating range. Note that measurements are made at the cell stack (not the pack connector). Therefore internal resistance drops due to the shunt, safety components, and contact resistance are not taken into consideration.

3.2.3.2. Temperature

The internal pack temperature is measured by an on-chip temperature sensor in thermal contact with the cell stack. Temperature readings have a resolution of 0.1°K. The absolute accuracy is $\pm 4^\circ\text{K}$ over an operating range of -10°C to $+80^\circ\text{C}$.

3.2.3.3. Current

The current measurements have a resolution of 1mA. The absolute accuracy of the reading is $\pm 1.5\%$ or $\pm 6\text{mA}$ whichever is greater over the operating range. A guard band has been imposed around zero current (-6mA to $+6\text{mA}$).

3.2.4. LCD Indication

The battery can directly display the capacity information. The battery capacity is displayed as the relative SOC. Each LCD segment represents 20 percent of the full charge capacity. The LCD pattern definition is given in the table below. If the battery voltage is below nominal 19.2V, there will be no LCD indication.

LCD Indicates will flash during charge.

Capacity	LCD Segments				
	1	2	3	4	5
Below 1%					
1% - 20%					
21% - 40%					
41% - 60%					
61% - 80%					
81% - 100%					



Battery Specification

Specification Number	DS421A10
Specification Revision	1.1
Prepared By	JAB
Issue date	1/27/16

3.3. SMBus and SBD Parameters

3.3.1. Overview Of Operations

The battery is fitted with a microprocessor and associated circuitry for communication with an external host device and/or smart battery charger. Reference should be made to the following specifications when reading this section:

- System Management Bus Specification (Rev 1.0, Feb 15, 1995)
- Smart Battery Data Specification (Rev 1.0, Feb 15, 1995)
- Smart battery Charger Specification (Rev 0.95a, Feb 15, 1995)

3.3.2. SMBus Logic Levels

Symbol	Parameter	Limits		Units
		Min	Max	
Vil	Data/Clock input low voltage		0.6	V
Vih	Data/Clock input high voltage	1.4	5.5	V
Vol			0.4	V

3.3.3. Communication Protocol

SMBus Interface complies with SBS Specification Version 1.0. The battery pack includes a simple bi-directional serial data interface. A host processor uses the interface to access various battery pack registers.

3.3.4. Initialization Procedure

The interface uses a command-based protocol, where the host processor sends the battery address command byte to the battery pack. The command directs the battery pack to either store the next data received to a register specified command byte or output the data specified by the command byte.

The Bus Host communicates with the battery pack using one of three protocols:

- Write Word
- Read Word
- Read Block

Specification Number	DS421A10
Specification Revision	1.1
Prepared By	JAB
Issue date	1/27/16

Battery Specification

3.3.4.1. Write Word

The first byte of a Write Word access is the command code. The next two Bytes are the data to be written. In this example the master asserts the slave device address followed by the write bit. The slave device acknowledges and the master delivers the command code. The slave again acknowledges before the master sends the data word (low byte first). The slave acknowledges each byte according to the I²C specification, and the entire transaction is finished with a stop condition.

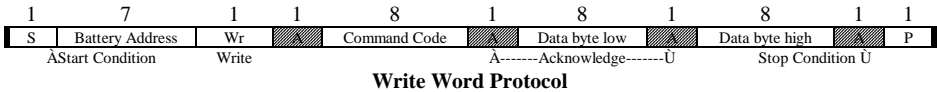

3.3.4.2. Read Word

Reading data is slightly more complex than writing data. First the host must write a command to the slave device. Then it must follow that command with a repeated start condition to denote a read from that device's address. The slave then returns two bytes of data.

Note that there is not a stop condition before the repeated start condition, and that a "Not Acknowledge" signifies the end of the read transfer.

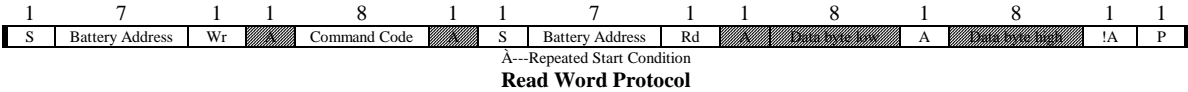

3.3.4.3. Block Read

The Block Read begins with a slave address and a write condition. Then it must follow that command with a repeated start condition to denote a read from that device's address. After the repeated start the slave issues a byte count that describes how many data bytes will follow in the message. If a slave had 20 bytes to send, the first byte would be the number 20 (14h), followed by the 20 bytes of data. The byte count may not be 0. A Block Read can transfer a maximum of 32 bytes.

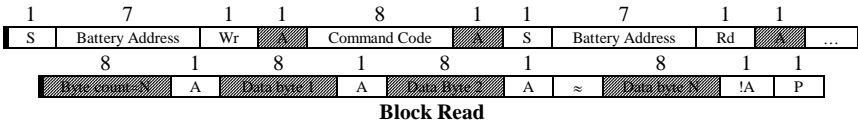



Battery Specification

Specification Number	DS421A10
Specification Revision	1.1
Prepared By	JAB
Issue date	1/27/16

3.3.5. Communicating with the Host

A message destined for the host could appear from an unknown device in an unknown format. To prevent possible confusion on the host part, only one method of communication is allowed -- a modified Write Word. This protocol is used when an SMBus device becomes a master to communicate with the SMBus host acting as a slave.

Device to Host communication will begin with the host address. The message's Command Code will actually be the initiating device's address. The host now knows the origin of the following 16 bits of device status.

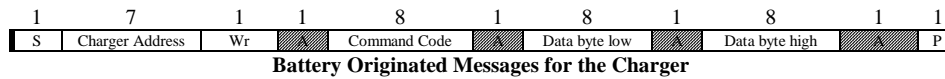

Smart Battery (master)
 Smart Battery Charger (slave)

Note : For the detail and the latest information, please refer to the Web Site address : “www.sbs-forum.org”

3.3.6. Host To Battery Message (Slave Mode)

The Host acting in the role of a bus master, uses the read word, write word, and read block protocols to communicate with the battery, operating in slave mode.



Battery Specification

Specification Number	DS421A10
Specification Revision	1.1
Prepared By	JAB
Issue date	1/27/16

Host-to-Battery Messages

Function	Command Code	Description	Unit	Access	Default (POR)
ManufacturerAccess()	0x00			r/w	
RemainingCapacityAlarm()	0x01	Remaining Capacity Alarm Threshold .	mAh	r/w	340
RemainingTimeAlarm()	0x02	Remaining Time Alarm Threshold.	minutes	r/w	10
BatteryMode()	0x03	Battery Operational Modes.	Bit flags	r/w	0x0080
AtRate()	0x04	This function is the first half of a two-function call-set used to set the AtRate value used in calculations made by the AtRateTimeToFull(), AtRateTimeToEmpty(), and AtRateOK() functions.	mA	r/w	0
AtRateTimeToFull()	0x05	Returns the predicted remaining time to fully charge the battery at the AtRate() value.	minutes	r	65535
AtRateTimeToEmpty()	0x06	Returns the predicted remaining operating time if the battery is discharged at the AtRate() value.	minutes	r	65535
AtRateOK()	0x07	Returns a Boolean value that indicates whether or not the battery can deliver the AtRate value of additional energy for 10 seconds. If the AtRate() value is zero or positive, the AtRateOK() function will ALWAYS return TRUE.	boolean	r	1
Temperature()	0x08	Returns the pack's internal temperature.	0.1 °K	r	
Voltage()	0x09	Returns the battery's voltage (measured at the cell stack)	mV	r	
Current()	0x0a	Returns the current being supplied (or accepted) through the battery's terminals.	mA	r	0
AverageCurrent()	0x0b	Returns a rolling average based upon the last 64 samples of current.	mA	r	0
MaxError()	0x0c	Returns the expected margin of error.	percent	r	10
RelativeStateOfCharge()	0x0d	Returns the predicted remaining battery capacity expressed as a percentage of FullChargeCapacity().	percent	r	0
AbsoluteStateOfCharge()	0x0e	Returns the predicted remaining battery capacity expressed as a percentage of DesignCapacity().	percent	r	0
RemainingCapacity()	0x0f	Returns the predicted remaining battery capacity.	mAh	r	0
FullChargeCapacity()	0x10	Returns the predicted battery capacity when fully charged.	mAh	r	3060
RunTimeToEmpty()	0x11	Returns the predicted remaining battery life at the present rate of discharge.	minutes	r	65535
AverageTimeToEmpty()	0x12	Returns the rolling average of the predicted remaining battery life.	minutes	r	65535
AverageTimeToFull()	0x13	Returns the rolling average of the predicted remaining time until the battery reaches full charge.	minutes	r	65535
ChargingCurrent()	0x14	Returns the battery's desired charging rate.	mA	r	1500
ChargingVoltage()	0x15	Returns the battery's desired charging voltage.	mV	r	33600
BatteryStatus()	0x16	Returns the battery's status word.	Bit flags	r	0x2C0
CycleCount()	0x17	Returns the number of cycles the battery has experienced. A cycle is defined as: An amount of discharge approximately equal to the value of the DesignCapacity.	cycles	r	0
DesignCapacity()	0x18	Returns the theoretical capacity of the new battery.	mAh	r	3400
DesignVoltage()	0x19	Returns the theoretical voltage of a new battery.	mV	r	28800
SpecificationInfo()	0x1a	Returns the version number of the SBDS the battery pack supports, as well as voltage and current scaling information.	Formatted word	r	0x0010
ManufacturerDate()	0x1b	Returns the date the electronics was manufactured.	Formatted word	r	
SerialNumber()	0x1c	Returns the electronics serial number.	number	r	
Reserved	0x1d - 0x1f			r	
ManufacturerName()	0x20	Returns a character array containing the manufacture's name.	string	r	INSPIREDE
DeviceName()	0x21	Returns a character array that contains the battery's name.	string	r	PH2059HD
DeviceChemistry()	0x22	Returns a character array that contains the battery's chemistry.	string	r	LION
ManufacturerData()	0x23	Returns data specific to the manufacture.		r	



Battery Specification

Specification Number	DS421A10
Specification Revision	1.1
Prepared By	JAB
Issue date	1/27/16

3.3.7. Battery To Charger Messages (Master Mode)

The battery, acting in the role of a bus master, uses the write word protocol to communicate with the charger, operating in slave mode. If the CHARGER_MODE bit in BatteryMode() is clear, the Battery will broadcast Charger request information at 15-second intervals.

Battery-to-Charger Messages

Function	Command Code	Description	Unit	Access
ChargingCurrent()	0x14	Sends the desired charging rate to the battery charger	mA	W
ChargingVoltage()	0x15	Sends the desired charging voltage to the battery charger	mV	W

3.3.8. Critical Messages (Master Mode)

Whenever the Battery detects a critical condition, it takes the role of a bus master and sends AlarmWarning() message to the Host and/ or Charger. The Battery broadcasts the AlarmWarning() message at 10 second intervals until the critical condition(s) has been corrected.

Battery Critical Messages

Function	Command Code	Description	Unit	Access
AlarmWarning()	0x16	This message is to the host and/or charger to notify them that one or more alarm conditions exist.	Formatted word	W

Alarm Bit Definitions

Hex	Battery Status	Status	Definition
4000	TERMINATE_CHARGE_ALARM	ON	Battery is requesting 0 ChargingCurrent() and the charger continues to supply current.
		OFF	When either condition is removed.
1000	OVER_TEMP_ALARM	ON	If charging and the "Temperature()" >= 54°C or discharging and the "Temperature()" >= 65°C.
		OFF	If charging and the "Temperature()" drops below 46°C or during discharge and the "Temperature()" drops below 60°C.
800	TERMINATE_DISCHARGE_ALARM	ON	During discharge when a cell voltage drops ≤ 2.6V.
		OFF	When either condition is removed.
200	REMAINING_CAPACITY_ALARM (User settable)	ON	Battery detects that its RemainingCapacity() is less than that set by the RemainingCapacityAlarm().
		OFF	Either the value set by the RemainingCapacityAlarm() is lower than the RemainingCapacity() OR when the RemainingCapacity() is increases by charging the battery.
100	REMAINING_TIME_ALARM (User settable)	ON	Battery detects that the estimated remaining time at the present discharge rate is less than that set by the RemainingTimeAlarm().
		OFF	Either the value set by the RemainingTimeAlarm() is lower than the AverageTimeToEmpty() OR when the AverageTimeToEmpty() is increases by charging the battery.



Battery Specification

Specification Number	DS421A10
Specification Revision	1.1
Prepared By	JAB
Issue date	1/27/16

Status Bit Definitions

80	INITIALIZED	ON	Always
		OFF	
40	DISCHARGING	ON	Battery "Current()" is not positive
		OFF	Battery "Current()" is positive
20	FULLY_CHARGED	ON	When the battery is being charged and "Current()" declines $\leq 103\text{mA}$ and the battery "Voltage()" $\geq 33096\text{V}$.
		OFF	When the SOC of the battery declines 3% from the "FULLY_CHARGE" detection point.
10	FULLY_DISCHARGED	ON	For any cell Voltage: If $I < 3000\text{mA}$ then 2.9V Else 2.6V**
		OFF	"RelativeStateOfCharge()" $\geq 20\%$.

Note:

** The host device should initiate a 'Save-To-Disk' action when the battery broadcast the TERMINATE_DISCHARGE Alarm during discharge. If the battery discharge continues until the under-voltage protection is activated, battery conditioning & cycle count data will be lost and will revert to POR values.

3.3.9. Definition Of Valid Calibration Cycle

Calibration is the process whereby the battery's fuel gauge is adjusted to maintain an acceptable level of accuracy. This may be necessary if a battery has aged or has been subjected to an unusual usage pattern. A battery can be calibrated by performing the following procedure:

1. Discharge the battery until the TERMINATE_DISCHARGE_ALARM in the BatteryStatus() is set (cell voltage $\leq 2.6\text{V}$).
2. Charge the battery at 33.6V (as measured across the battery terminals) and with a current limit no greater than 1500mA. Charge the battery until the TERMINATE_CHARGE_ALARM in the BatteryStatus() is set (Current() $\leq 103\text{mA}$). Repeat step 1.

Note, Calibration is invalid if:

- Pack Voltage goes below nominal 19.2V.
- Pack Temperature goes below 15°C or exceeds 60°C during a calibration cycle.
- Accumulative self-discharge is more than 3% of the FullChargeCapacity().

Notes On Calibration And Maximum Error:

Although Inspired Energy's detailed modeling of cell characteristics ensures that the most accurate correction factors are applied to the fuel gauge capacity to compensate for the effects of time, temperature, usage patterns and charge/discharge rates - it is inevitable that the fuel gauge accuracy will drift with time.

The smart electronics know the actual capacity at only two reference points: 'empty' and 'fully charged'. When either of these two points is reached, the predicted capacity is compared with the known capacity and an error factor is calculated (Max Error). It is recommended that the application software indicate to the user that the battery should be calibrated when a pre-determined max error limit is reached (10% for example).

At the completion of the calibration cycle, the CONDITION_FLAG in the BatteryMode() register will be reset.



Battery Specification

Specification Number	DS421A10
Specification Revision	1.1
Prepared By	JAB
Issue date	1/27/16

3.4. Protection Electronics

3.4.1. Overview Of Operation

Electronic circuitry is permanently connected within the battery pack to prevent damage if either the charger or host device fails to function correctly. The circuitry also protects the battery if an illegal current source is placed across the battery terminals, or an illegal load is connected. Redundant levels of protection have been implemented (the first levels are auto-resettable and the latter are non-resettable).

3.4.2. Charge Protection

Over-Voltage:

The micro-controller will prevent the battery from charging at a voltage of 4.30V +/-0.5% or more per cell. Then, once the battery voltage is lowered to 4.20V +/-0.5% or less per cell, it will allow charging again. If the battery is being charged at 4.35V +/-25mV or more per cell, the protection circuit will blow the in-line logic fuse.

Over-temp:

The micro-controller circuit also provides over-temperature protection and will prevent the battery from charging at temperatures $\geq 58 \pm 4^\circ\text{C}$. Then, once the battery temperature has cooled to $\leq 54 \pm 4^\circ\text{C}$, it will again allow charging.

Over-Current:

The micro-controller circuit also provides continuous over-current protection and will prevent the battery from charging at currents $\geq 2.0\text{A} \pm 1.5\%$. Then, at periodic intervals, the battery will re-test the over-current condition, and again allow charging.

3.4.3. Discharge Protection

Under-Voltage:

The micro-controller circuit will prevent the battery from being further discharged once any voltage reaches $2.6\text{V} \pm 0.5\%$ or less per cell. Then, once the battery voltage has risen by charging, it will allow the battery to be discharge again. Additional under-voltage protection is ensured by the on-board circuitry going into sleep mode at a nominal battery voltage of 19.2V – which disables discharge.

Over-temp:

The micro-controller circuit also provides over-temperature protection and will prevent the battery from discharging at temperatures $\geq 65 \pm 4^\circ\text{C}$. Then, once the battery temperature has cooled to $\leq 60 \pm 4^\circ\text{C}$, it will again allow discharging.

Over-Current:

The micro-controller circuit also provides continuous over-current protection and will prevent the battery from discharging at currents $\geq 4.0\text{A} \pm 1.5\%$. Then, at periodic intervals, the battery will re-test the over-current condition, and again allow discharging.



Battery Specification

Specification Number	DS421A10
Specification Revision	1.1
Prepared By	JAB
Issue date	1/27/16

The micro-controller circuit will prohibit the discharge of the battery if a short-circuit is placed across the battery + / - terminals. Then, at periodic intervals, the battery will re-test the short-circuit condition, and again allow discharging.

Addition over-current protection is also provided by the passive slow-blow fuse discussed later.

3.5. Passive Safety Protection

3.5.1. Overview Of Operation

The battery pack is fitted with additional components to protect it against abusive charge and discharge conditions. These are in addition to the electronic protection.

3.5.2. Slow-Blow Current Fuse

A current slow-blow fuse is assembled in series with the battery pack to protect the battery pack against abusive over current over-load. The hold current is rated at 12A for 4 hours (minimum). The fuse is non-resettable, rendering the battery pack non-functional.

3.6. Mechanical Specifications

3.6.1. Weight

Approximately 0.45 Kg.

3.6.2. Mating Connector

The recommended interconnection mating connectors are:

PC board mount:

Amphenol p/n L177TWA7W2PMP3SVC745 with male signal pins, Inspired Energy p/n 619017

Cable mount:

- Amphenol L177TWA7W2P connector shell with male signal pins, Inspired Energy p/n 699010
- Amphenol L17DM53745-1 40A male solder cup inserts (2 required), Inspired Energy p/n 699011
- Amphenol L17DTZK15K optional protective backshell, Inspired Energy p/n 699012

Items a & b are available as a kit, Inspired Energy p/n 699013

Items a,b,c along with 2 nut-screws are available as a kit, Inspired Energy p/n 699014



Battery Specification

Specification Number	DS421A10
Specification Revision	1.1
Prepared By	JAB
Issue date	1/27/16

3.6.3. Date Code/Serial Number

A date code and the serial number is stamped on each pack (reference the mechanical drawing).

IE YYWWRR

SN SSSSS XZZAh

IE = Inspired Energy Newberry facility

YY = Calendar Year

WW = Calendar Week

RR = Battery revision

SSSSS = Serial Number

X = the cell supplier

ZZAh = the stored energy of the battery in Amp hours

3.6.4. Packaging

The batteries are packaged in bulk, with 10 batteries per carton.

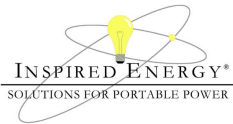

Battery Specification

Specification Number	DS421A10
Specification Revision	1.1
Prepared By	JAB
Issue date	1/27/16

3.6.5. Mechanical Drawing

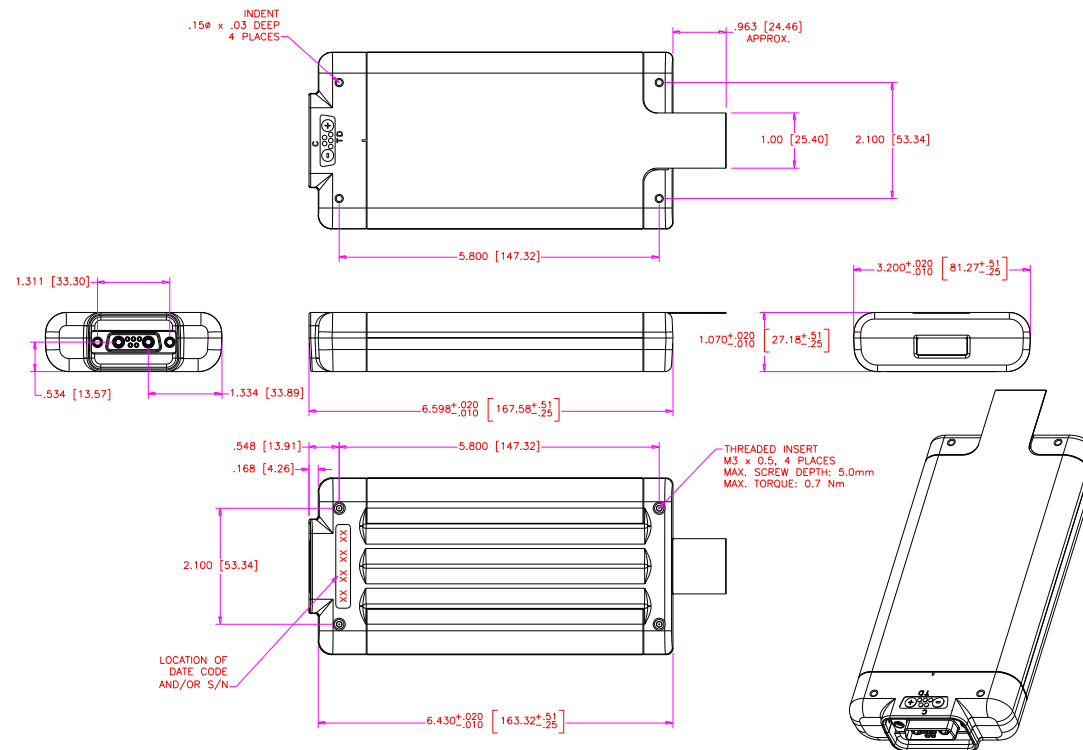



Battery Specification

Specification Number	DS421A10
Specification Revision	1.1
Prepared By	JAB
Issue date	1/27/16

3.7. Environmental/Safety Specifications

3.7.1. EMC And Safety

The battery complies with the following:

- EMC Directive 2004/108/EC
- Low Voltage Directive 2006/95/EC
- Battery Recycling Directive 2006/66/EC as amended
- “RoHS“ Directive 2011/65/EU

The battery tested in accordance with the UN Manual of tests and Criteria part III subsection 38.3 (ST/SG/AC.10/11/Rev.3) - more commonly known as the UN T1-T8 Transportation tests; and has been found to comply with the stated criteria. [USDOT-E7052]

The battery has been tested for the following approvals and the pack will be labeled accordingly:

- FCC
- CE
- Product Safety EN 60950

3.8. Reliability

3.8.1. Life Expectancy

Given normal storage & usage, the user can expect the battery to deliver 1026 mAh or more after 300 charge/discharge cycles where the charge phase is CC/CV 1500mA, $33.6 \pm 0.05V$ and the discharge is 680mA down to 2.6V/Cell at 25°C.

3.8.2. Warranty

A high quality standard is maintained by Inspired Energy. All products are warranted against defects in workmanship, material and construction. The warranty period is one (1) year from the date of shipment from Inspired Energy.

3.8.3. Shelf Life

The batteries are shipped from Inspired Energy with between 20% and 30% rated capacity and this provides a minimum of 6 months shelf life, when stored at 25°C. If the storage temperature exceeds 25°C over the 6-month period then the shelf life will be reduced and provisions should be made to recharge the battery periodically.

In order to prevent parasitic drain on the battery, the electronics will go into a shutdown mode at a nominal battery voltage of 19.2V. If this should happen, the battery pack will require an initial low charge to activate the electronics prior to the implementation of the normal charge. Any SMBus version 1.0, or higher, compatible charger is capable of providing this initial pre-charge.