

## **Battery Specification**

### **Document Number & Revision**

DSNL2024ED22

### **Description**

Rechargeable Smart Lithium Ion Battery Pack

### **Inspired Energy Part Number For Battery**

NL2024ED22

### **Statement Of Confidentiality**

The information contained within this document is confidential and proprietary to Inspired Energy. This information should not, in whole or in part, be reproduced, disclosed or used except as expressly and duly authorized by Inspired Energy.

This information is descriptive only. No representation, guarantee or warranty of merchantability or fitness for purpose is made or implied. Specifications are subject to change without notice.



|                        |              |
|------------------------|--------------|
| Specification Number   | DSNL2024ED22 |
| Specification Revision | 3.1          |
| Prepared By            | JAB          |
| Issue date             | 1/26/16      |

# Battery Specification

## TABLE OF CONTENTS

- 1. REVISION HISTORY .....4**
- 2. INTRODUCTION .....4**
  - 2.1. SCOPE.....4
  - 2.2. BATTERY PACK OVERVIEW .....4
  - 2.3. GENERAL PRECAUTIONS .....5
    - 2.3.1. *Handling* .....5
    - 2.3.2. *Charge & Discharge*.....5
    - 2.3.3. *Storage*.....5
    - 2.3.4. *Disposal*.....5
- 3. REQUIREMENTS.....5**
  - 3.1. GENERAL REQUIREMENTS .....5
    - 3.1.1. *Nominal Voltage* .....5
    - 3.1.2. *Rated Capacity*.....5
    - 3.1.3. *Initial Impedance* .....6
    - 3.1.4. *Discharge*.....6
    - 3.1.5. *Charge* .....7
    - 3.1.6. *Storage*.....8
    - 3.1.7. *Terminal Specifications* .....8
  - 3.2. FUEL-GAUGE ELECTRONICS .....8
    - 3.2.1. *Overview Of Operation*.....8
    - 3.2.2. *DC Specifications* .....9
    - 3.2.3. *Measurement Accuracy*.....10
      - 3.2.3.1. *Voltage*.....10
      - 3.2.3.2. *Temperature* .....10
      - 3.2.3.3. *Current* .....10
    - 3.2.4. *LED Indication* .....10
  - 3.3. SMBUS AND SBD PARAMETERS .....10
    - 3.3.1. *Overview Of Operations* .....10
    - 3.3.2. *SMBus Logic Levels*.....11
    - 3.3.3. *SMBus Data Protocols*.....11
    - 3.3.4. *SMBus Host-to-Battery Message Protocol* .....11
      - 3.3.4.1. *Write Word* .....11
      - 3.3.4.2. *Read Word* .....12
      - 3.3.4.3. *Block Read*.....12
    - 3.3.5. *SMBus Battery-to-Charger Message Protocol* .....12
    - 3.3.6. *SMBus Battery Critical Message Protocol* .....13
    - 3.3.7. *Host To Battery Messages (Slave Mode)* .....13
    - 3.3.8. *Battery To Charger Messages (Master Mode)*.....15
    - 3.3.9. *Critical Messages (Master Mode)*.....15
    - 3.3.10. *Pack Calibration Cycle*.....16
  - 3.4. PROTECTION ELECTRONICS .....16
    - 3.4.1. *Overview Of Operation*.....16
    - 3.4.2. *Charge Protection* .....17
    - 3.4.3. *Discharge Protection*.....17



|                        |              |
|------------------------|--------------|
| Specification Number   | DSNL2024ED22 |
| Specification Revision | 3.1          |
| Prepared By            | JAB          |
| Issue date             | 1/26/16      |

# Battery Specification

- 3.4.4. *Short-Current Protection*..... 17
- 3.5. PASSIVE SAFETY PROTECTION..... 18
  - 3.5.1. *Overview Of Operation*..... 18
  - 3.5.2. *Thermal Fuse* ..... 19
  - 3.5.3. *Slow-Blow Current Fuse (Logic Fuse)* ..... 19
- 3.6. MECHANICAL SPECIFICATIONS ..... 19
  - 3.6.1. *Weight*..... 19
  - 3.6.2. *Mating Connector*..... 19
  - 3.6.3. *Date Code/Serial Number*..... 19
  - 3.6.4. *Packaging* ..... 19
  - 3.6.5. *Mechanical Drawing* ..... 20
- 3.7. ENVIRONMENTAL/SAFETY SPECIFICATIONS ..... 22
  - 3.7.1. *EMC And Safety*..... 22
- 3.8. RELIABILITY ..... 22
  - 3.8.1. *Life Expectancy*..... 22
  - 3.8.2. *Warranty*..... 22
  - 3.8.3. *Shelf Life* ..... 22



|                        |              |
|------------------------|--------------|
| Specification Number   | DSNL2024ED22 |
| Specification Revision | 3.1          |
| Prepared By            | JAB          |
| Issue date             | 1/26/16      |

# Battery Specification

## 1. REVISION HISTORY

| Revision | Release Date | Revisions                                      | Issued By | Approved By |
|----------|--------------|--|-----------|-------------|
| 1.0      | 2/19/09      | Release.                                       | RAH       | DB, LJ      |
| 2.0      | 12/14/09     | Changed Reported DeviceName.                   | RAH       | DB, LJ      |
| 3.0      | 1/2/14       | Changed controller and DeviceName toNL2024ED22 | JAB       | RAH,DB,LJ   |
| 3.1      | 1/26/16      | Changed shipping s-o-c                         | LJ        | LJ          |

## 2. INTRODUCTION

### 2.1. Scope

This specification describes the physical, functional and electrical characteristics of a rechargeable Lithium Ion battery pack supplied by Inspired Energy. This specification is the interface document between Inspired Energy and its customers. It is understood that the customer may create their own internal specification. However, this specification is the master that defines the battery’s operation. Battery packs produced will meet this specification.

### 2.2. Battery Pack Overview

This specification describes the physical, functional and electrical requirements for the NL2024HD Smart Battery including a rechargeable Lithium Ion battery and a Battery Management Module. The battery consists of (12) Lithium Ion rechargeable cells of 18650 size, assembled in a 4 series / 3 parallel (4S 3P) configuration. Each cell has an average voltage of 3.6V and a typical capacity of 2.2Ah giving a battery pack of 14.4V and 6.6Ah typical.

The battery is capable of communicating with host or the charger through the System Management Bus (SMBus). The battery is fully SMBus and SBDS Revision 1.1 compliant. Protection is provided for over-charge, over-discharge and short circuit. For redundancy, passive safety devices have been integrated into the pack to protect against over-current and over-temperature, and secondary over-voltage has been implemented with a logic-fuse and controller.

The battery pack comprises the individual elements as shown below.

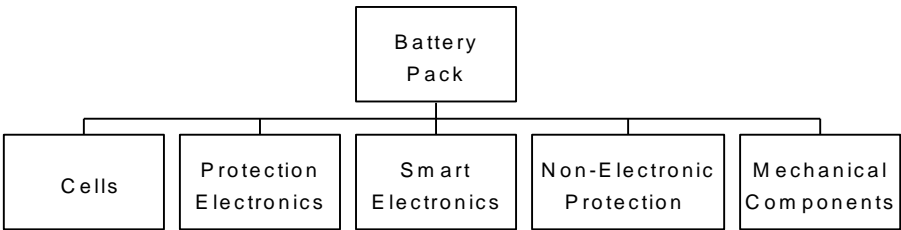



|                        |              |
|------------------------|--------------|
| Specification Number   | DSNL2024ED22 |
| Specification Revision | 3.1          |
| Prepared By            | JAB          |
| Issue date             | 1/26/16      |

## Battery Specification

### 2.3. General Precautions

#### 2.3.1. Handling

- Avoid shorting the battery
- Do not immerse in water.
- Do not disassemble or deform the battery
- Do not expose to, or dispose of the battery in fire.
- Avoid excessive physical shock or vibration.
- Keep out of the reach of children.
- Never use a battery that appears to have suffered abuse.

#### 2.3.2. Charge & Discharge

- Battery must be charged in appropriate charger only.
- Never use a modified or damaged charger.
- Specified product use only.

#### 2.3.3. Storage

- Store in a cool, dry and well-ventilated area.

#### 2.3.4. Disposal

- Regulations vary for different countries. Dispose of in accordance with local regulations.

## 3. REQUIREMENTS

### 3.1. General Requirements

#### 3.1.1. Nominal Voltage

The battery nominal operating voltage is 14.4V.

#### 3.1.2. Rated Capacity

The initial capacity is  $\geq 6270\text{mAh}$  (based on a CV charge of  $16.8\text{V} \pm 50\text{mV}$  with a current limit of 4A and a 1320mA discharge to 11.00V @ 25C, within 1 hour of charge).



|                        |              |
|------------------------|--------------|
| Specification Number   | DSNL2024ED22 |
| Specification Revision | 3.1          |
| Prepared By            | JAB          |
| Issue date             | 1/26/16      |

## Battery Specification

### 3.1.3. Initial Impedance

The internal impedance of a fully charged battery shall be  $< 165\text{m}\Omega$  when measured across the positive and negative battery terminals at 1kHz at 20°C.

### 3.1.4. Discharge -20C to +60C

Discharge Temperature Limits: As shown below,  $\leq 80\%RH$

The battery shall be capable of continuous discharge within the Operating Boundary as shown in the graph below.

Host devices should be designed for a controlled shutdown following battery notification of termination by the battery sending TERMINATE\_DISCHARGE alarm, prior to protection circuit cut-off.

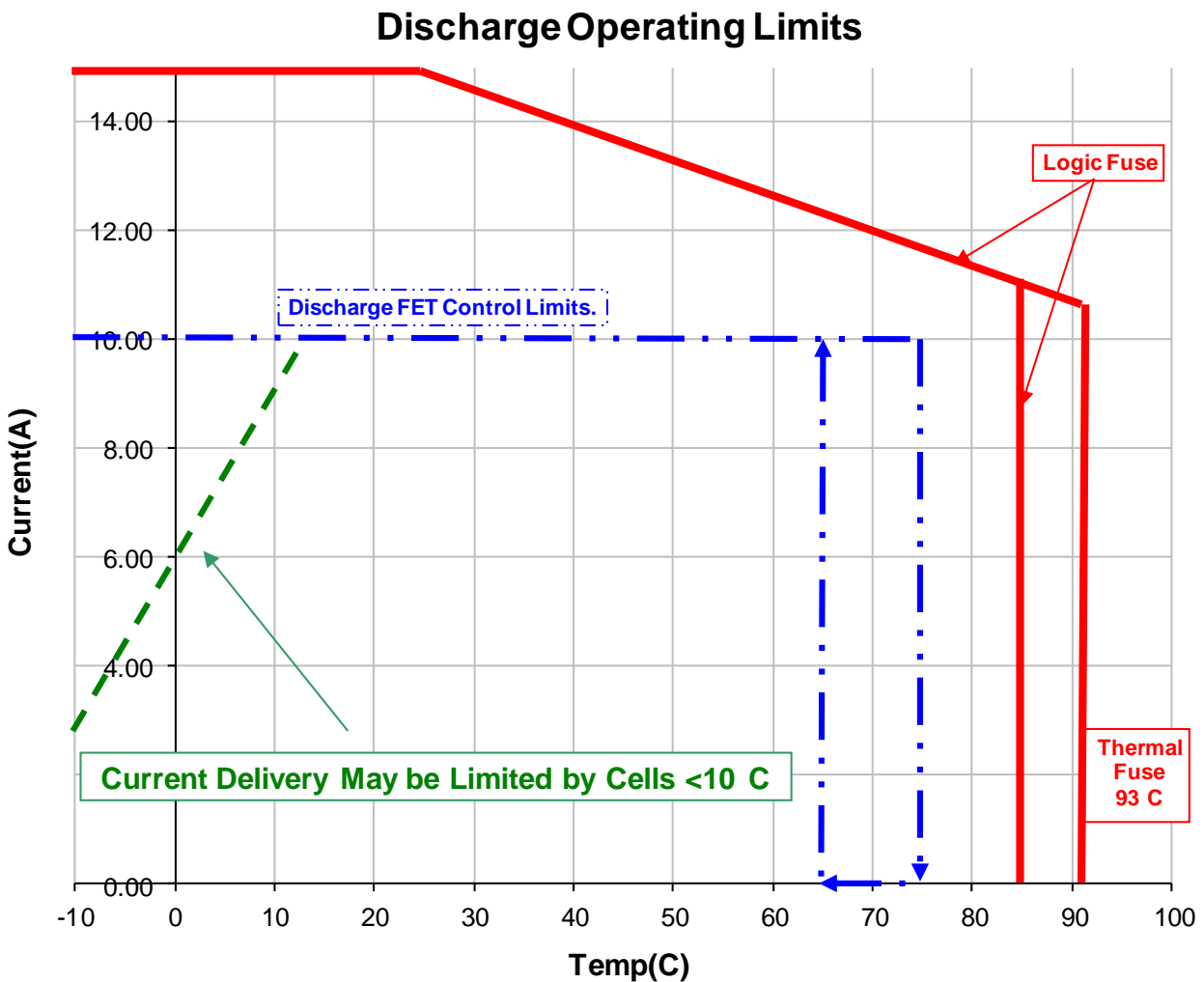



|                        |              |
|------------------------|--------------|
| Specification Number   | DSNL2024ED22 |
| Specification Revision | 3.1          |
| Prepared By            | JAB          |
| Issue date             | 1/26/16      |

# Battery Specification

## 3.1.5. Charge 0C to 45C

Charge Temperature Limits: As Shown below,  $\leq 80\%RH$

The battery shall be capable of continuous charge at 16.8V, as shown in the graph below. A dedicated level II or level III smart battery charger is required to charge the battery. Using this type of charger, the battery will request appropriate charging Voltage and Current from the smart battery charger.

The FULLY\_CHARGED bit in the BatteryStatus() will be set when the charging current tapers down under 220mA while charging at 16.8V.

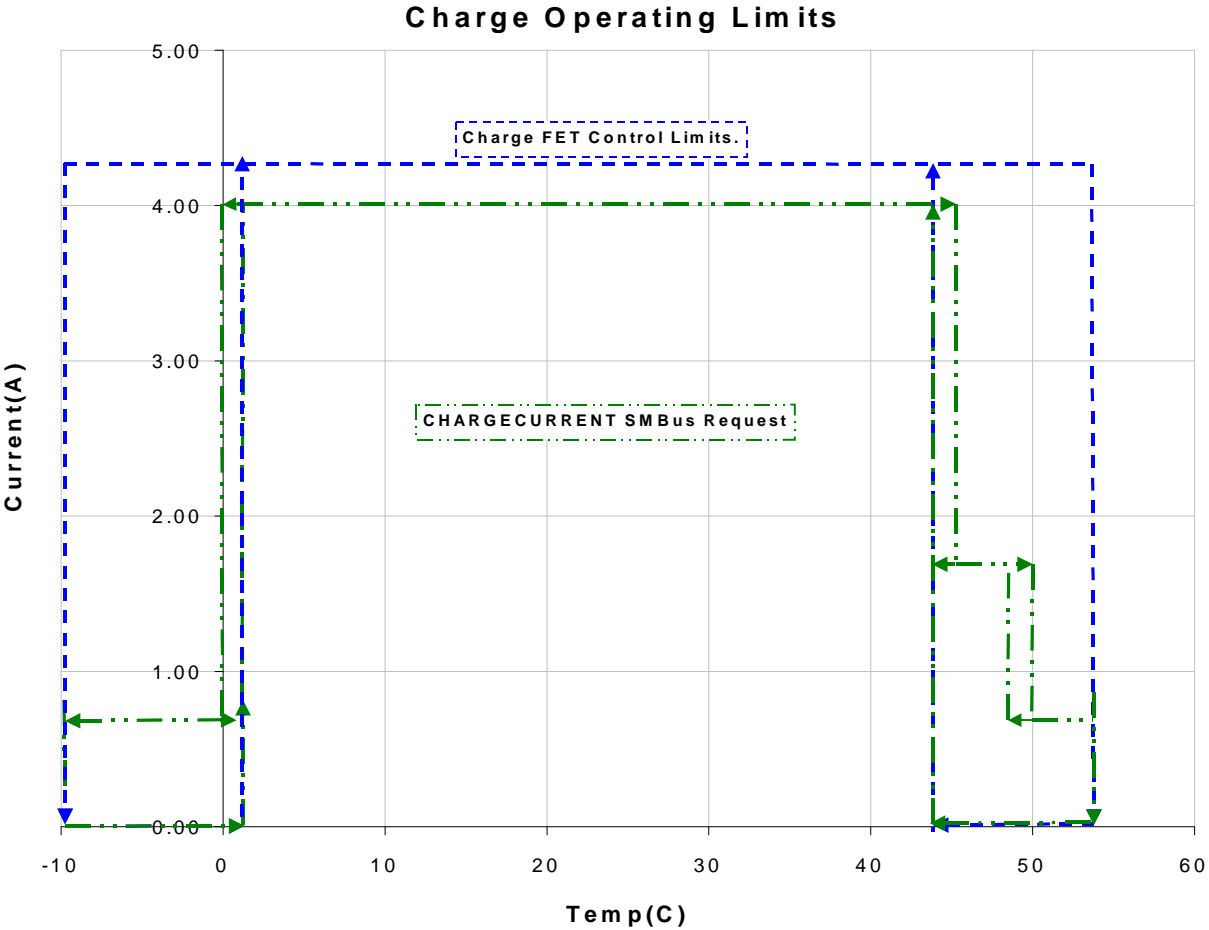

NOTE: If not charging & temperature > 45C then the battery enters Charge-Inhibit where ChargingCurrent() = 0 & ChargeVoltage() = 0 until temperature  $\leq 44C$



|                        |              |
|------------------------|--------------|
| Specification Number   | DSNL2024ED22 |
| Specification Revision | 3.1          |
| Prepared By            | JAB          |
| Issue date             | 1/26/16      |

## Battery Specification

### 3.1.6. Storage

Storage Temperature Limits:  $-20^{\circ}\text{C}$  to  $60^{\circ}\text{C}$ ,  $\leq 80\% \text{RH}$

The battery packs should be stored in an environment with low humidity, free from corrosive gas at a recommended temperature range  $<21^{\circ}\text{C}$ . Extended exposure to temperatures above  $45^{\circ}\text{C}$  could degrade battery performance and life.

### 3.1.7. Terminal Specifications

See Mechanical Drawing for orientation of contacts J1-1,5

| Terminal | Legend | Description  |
|----------|--------|--|
| 1        | (+)    | Positive side of battery   |
| 2        | (C)    | SMBus Clock. Internally a $1\text{M}\Omega$ resistor is connected between (C) and (-). |
| 3        | (D)    | SMBus Data. Internally a $1\text{M}\Omega$ resistor is connected between (D) and (-).  |
| 4        | (T)    | $300\Omega \pm 5\%$ resistor connected between (T) and (-).                            |
| 5        | (-)    | Negative Side Of Battery   |

- A key slot is also present on each pack for mechanical alignment adjacent to the positive terminal.
- The SMBus Clock and data lines require separate pull-ups to system logic voltage, NOT the battery voltage. Typically a  $15\text{K}\Omega$  pull-up resistor is used, but please refer to the SMBus Specification for additional information.

## 3.2. Fuel-Gauge Electronics

### 3.2.1. Overview Of Operation

The battery is capable of communicating with host or the charger through the System Management Bus (SMBus). The battery is fully SMBus and SBDS Revision 1.1 compliant. An 8-bit Reduced Instruction Set CPU (RISC) is used to process the core algorithms and perform operations required for battery monitoring. Charge and discharge current, cell and pack voltages, and pack temperature are all measured using an integrated analog to digital converter at 14-bit to 16-bit effective resolution.

The battery pack uses a system level approach to optimize the performance of the battery. It's primary functions are to provide fuel gauging and software based charge control, and to ensure safe operation throughout the life cycle of the battery.

The fuel gauge determines the State-Of-Charge (SOC) by integrating the input and output current and using impedance tracking to accurately track the available capacity of the attached battery. To achieve the desired fuel-gauging accuracy, high-performance analog peripherals are used to monitor capacity change, battery impedance, open-circuit voltage and temperature. These factors are continually applied to account for battery non-linearity and environmental conditions. This approach provides the user a meaningful and repeatable capacity measure with minimal risk of overstating run time. Visually, the SOC can be obtained from the four on-pack LED's with push-button activation.



|                        |              |
|------------------------|--------------|
| Specification Number   | DSNL2024ED22 |
| Specification Revision | 3.1          |
| Prepared By            | JAB          |
| Issue date             | 1/26/16      |

## Battery Specification

Charge control is used to provide optimal and safe charging requests to an SMBus level II or level III charger.

The system has three modes of operation; normal, sleep and shutdown. In normal mode, measurements, calculations, protection decisions and data updates are made on 1 sec intervals. Between these intervals, the electronics enters a reduced power mode. Sleep mode is entered when the system senses no host or charger present. While in this mode, battery parameters continue to be monitored at regular intervals. The system will continue in this mode until it senses host activity (communications or current flow). Shutdown mode occurs when the battery voltage falls below 2.3V/parallel cell group. In this mode, parasitic current is reduced to a minimum by shutting down the micro-controller and all associated circuitry. If this should happen, the battery will require an initial low current charge to bring the battery voltage back up before normal operation will resume.

The battery pack block diagram is shown below.

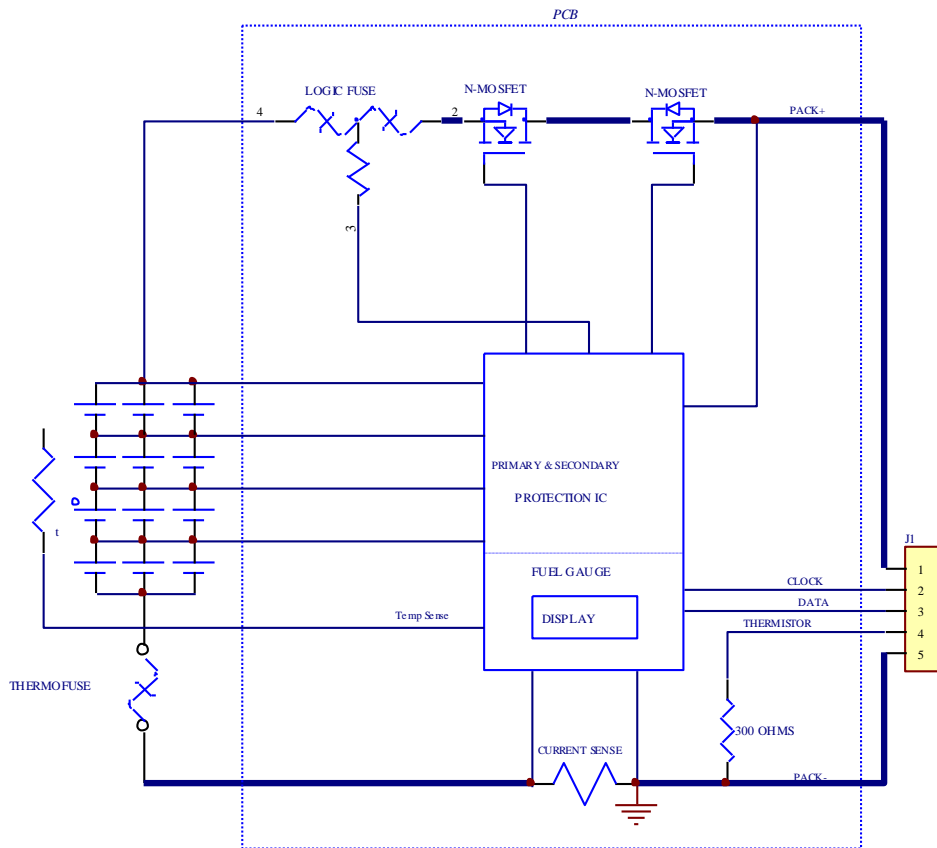

### 3.2.2. DC Specifications

| Parameter                          | Limits | Remarks  |
|------------------------------------|--------|--|
| Active mode current consumption    | <650uA | When a host is detected (charging, discharging or communications). |
| Standby mode current consumption   | <140uA | When no host activity is detected.                                 |
| Shut-down mode current consumption | <1uA   | Any cell voltage falls below 2300mV.                               |



|                        |              |
|------------------------|--------------|
| Specification Number   | DSNL2024ED22 |
| Specification Revision | 3.1          |
| Prepared By            | JAB          |
| Issue date             | 1/26/16      |

## Battery Specification

### 3.2.3. Measurement Accuracy

#### 3.2.3.1. Voltage

The voltage measurements have a resolution of 1mV. The absolute accuracy of the reading is  $\pm 0.7\%$  over the operating range. Note that measurements are made at the cell stack (not the pack connector). Therefore internal resistance drops due to the shunt, safety components, and contact resistance are not taken into consideration.

#### 3.2.3.2. Temperature

The internal pack temperature is measured by a NTC thermistor attached to the cell stack. Temperature readings have a resolution of 0.1°K. The absolute accuracy is  $\pm 3^\circ\text{K}$  over an operating range of  $-20^\circ\text{C}$  to  $+80^\circ\text{C}$ .

#### 3.2.3.3. Current

The current measurements have a resolution of 1mA. The absolute accuracy of the reading is  $\pm 0.7\%$  or  $\pm 3\text{mA}$  whichever is greater over the operating range. A guard band has been imposed around zero current ( $-3\text{mA}$  to  $+3\text{mA}$ ).

### 3.2.4. LED Indication

The battery can directly display the capacity information. The battery capacity is displayed as the relative SOC. Each LED segment represents 25 percent of the full charge capacity. The LED pattern definition is given in the table below. The LED's illuminate for 4 seconds following switch activation. If the battery voltage is too low, there will be no LED indication.

| Capacity        | LED Indicators # |   |   |   | Note               |
|-----------------|------------------|---|---|---|--------------------|
|                 | 1                | 2 | 3 | 4 |                    |
| At or below 10% |                  |   |   |   | Blinks             |
| 10% - 25%       |                  |   |   |   | Lit for 4 seconds. |
| 26% - 50%       |                  |   |   |   | Lit for 4 seconds. |
| 51% - 75%       |                  |   |   |   | Lit for 4 seconds. |
| 76% - 100%      |                  |   |   |   | Lit for 4 seconds. |

## 3.3. SMBus and SBD Parameters

### 3.3.1. Overview Of Operations

The battery is fitted with a microprocessor and associated circuitry for communication with an external host device and/or smart battery charger. Reference should be made to the following specifications when reading this section:

- System Management Bus Specification (Rev 1.1, Dec 11, 1998) with the exception that it is necessary to wait at least 150uS between battery message transactions.
- Smart Battery Data Specification (Rev 1.1, Dec 15, 1998)
- Smart battery Charger Specification (Rev 1.0, June 27, 1996)



|                        |              |
|------------------------|--------------|
| Specification Number   | DSNL2024ED22 |
| Specification Revision | 3.1          |
| Prepared By            | JAB          |
| Issue date             | 1/26/16      |

## Battery Specification

### 3.3.2. SMBus Logic Levels

| Symbol          | Parameter                     | Limits |     | Units |
|-----------------|-------------------------------|--------|-----|-------|
|                 |                               | Min    | Max |       |
| V <sub>il</sub> | Data/Clock input low voltage  | -0.3   | 0.8 | V     |
| V <sub>ih</sub> | Data/Clock input high voltage | 2.1    | 5.5 | V     |
| V <sub>ol</sub> | Data/Clock output low voltage |        | 0.4 | V     |

### 3.3.3. SMBus Data Protocols

SMBus Interface complies with SBS Specification Version 1.1. The battery pack includes a simple bi-directional serial data interface. A host processor uses the interface to access various battery pack registers. The interface uses a command-based protocol, where the host processor sends the battery address command byte to the battery pack. The command directs the battery pack to either store the next data received to a register specified command byte or output the data specified by the command byte.

### 3.3.4. SMBus Host-to-Battery Message Protocol

The Bus Host communicates with the battery pack using one of three protocols:

- Write Word
- Read Word
- Read Block

#### 3.3.4.1. Write Word

The first byte of a Write Word access is the command code. The next two Bytes are the data to be written. In this example the master asserts the slave device address followed by the write bit. The device acknowledges and the master delivers the command code. The slave again acknowledges before the master sends the data word (low byte first). The slave acknowledges each byte according to the I<sup>2</sup>C specification, and the entire transaction is finished with a stop condition.

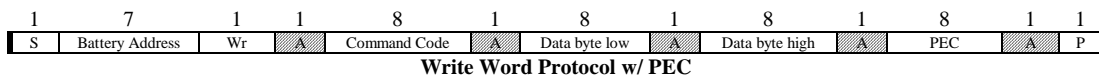
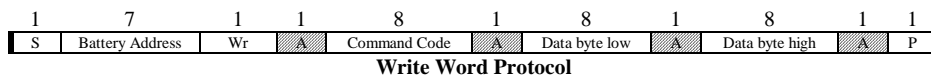

SMBus Host (master)



Smart Battery (slave)



|                        |              |
|------------------------|--------------|
| Specification Number   | DSNL2024ED22 |
| Specification Revision | 3.1          |
| Prepared By            | JAB          |
| Issue date             | 1/26/16      |

## Battery Specification

### 3.3.4.2. Read Word

Reading data is slightly more complex than writing data. First the host must write a command to the slave device. Then it must follow that command with a repeated start condition to denote a read from that device's address. The slave then returns two bytes of data.

Note that there is not a stop condition before the repeated start condition, and that a "Not Acknowledge" signifies the end of the read transfer.

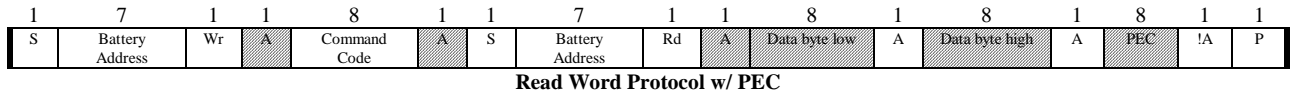
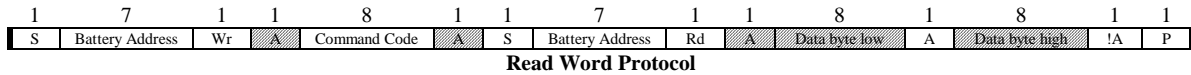

SMBus Host (master)
  Smart Battery (slave)

### 3.3.4.3. Block Read

The Block Read begins with a slave address and a write condition. Then it must follow that command with a repeated start condition to denote a read from that device's address. After the repeated start the slave issues a byte count that describes how many data bytes will follow in the message. If a slave had 20 bytes to send, the first byte would be the number 20 (14h), followed by the 20 bytes of data. The byte count may not be 0. A Block Read can transfer a maximum of 32 bytes.

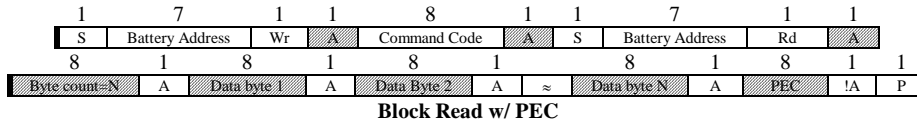
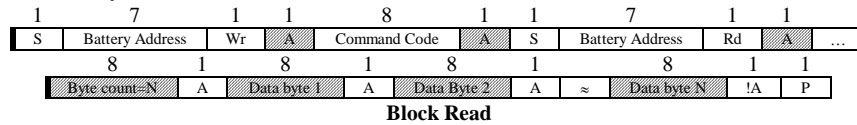

SMBus Host (master)
  Smart Battery (slave)

### 3.3.5. SMBus Battery-to-Charger Message Protocol

The Smart Battery, acting as an SMBus master will dynamically alter the charger characteristics of the Smart Charger, behaving as an SMBus slave using the SMBus Write Word protocol. Communication begins with the Smart Charge's address, followed by a Command Code and a two byte value. The Smart Charger adjust its output to correspond with the request.

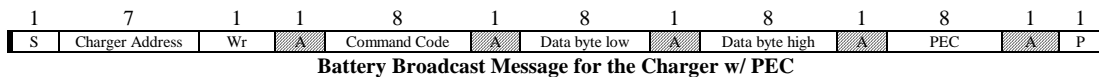
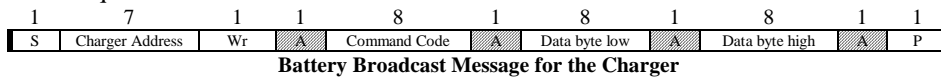



|                        |              |
|------------------------|--------------|
| Specification Number   | DSNL2024ED22 |
| Specification Revision | 3.1          |
| Prepared By            | JAB          |
| Issue date             | 1/26/16      |

# Battery Specification

Smart Battery (master)    
  Smart Charger (slave)

### 3.3.6. SMBus Battery Critical Message Protocol

A Smart Battery to SMBus Host or Smart Charger message is sent using the SMBus Write Word protocol. Communication begins with the SMBus Host's or Smart Battery Charger's address, followed by the Smart Battery's address which replaces the Command Code. The SMBus Host or Smart Charger can now determine that the Smart Battery was the originator of the message and that the following 16 bits are its status.

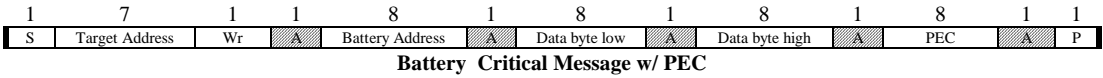
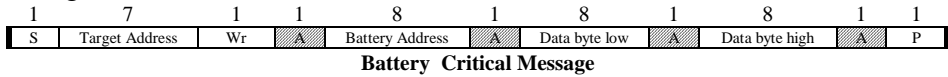

Smart Battery (master)    
  Smart Host or Smart Charger (slave)

### 3.3.7. Host To Battery Messages (Slave Mode)

The Host acting in the role of bus master uses the read word, write word, and read block protocols to communicate with the battery, operating in slave mode.



|                        |              |
|------------------------|--------------|
| Specification Number   | DSNL2024ED22 |
| Specification Revision | 3.1          |
| Prepared By            | JAB          |
| Issue date             | 1/26/16      |

## Battery Specification

### Host-to-Battery Messages

| Function                 | Command Code      | Description   | Unit           | Access | Default (POR) |
|--------------------------|-------------------|---|----------------|--------|---------------|
| ManufacturerAccess()     | 0x00              |   |                | r/w    |               |
| RemainingCapacityAlarm() | 0x01              | Remaining Capacity Alarm Threshold .  | mAh            | r/w    | 660           |
| RemainingTimeAlarm()     | 0x02              | Remaining Time Alarm Threshold.   | minutes        | r/w    | 10            |
| BatteryMode()            | 0x03              | Battery Operational Modes.  | Bit flags      | r/w    | 0x0081        |
| AtRate()                 | 0x04              | This function is the first half of a two-function call-set used to set the AtRate value used in calculations made by the AtRateTimeToFull(), AtRateTimeToEmpty(), and AtRateOK() functions.                                     | mA             | r/w    | 0             |
| AtRateTimeToFull()       | 0x05              | Returns the predicted remaining time to fully charge the battery at the AtRate() value.   | minutes        | r      | 65535         |
| AtRateTimeToEmpty()      | 0x06              | Returns the predicted remaining operating time if the battery is discharged at the AtRate() value.  | minutes        | r      | 65535         |
| AtRateOK()               | 0x07              | Returns a Boolean value that indicates whether or not the battery can deliver the AtRate value of additional energy for 10 seconds. If the AtRate() value is zero or positive, the AtRateOK() function will ALWAYS return TRUE. | boolean        | r      | 1             |
| Temperature()            | 0x08              | Returns the pack's internal temperature.  | 0.1 °K         | r      |               |
| Voltage()                | 0x09              | Returns the battery's voltage (measured at the cell stack)  | mV             | r      |               |
| Current()                | 0x0a              | Returns the current being supplied (or accepted) through the battery's terminals.   | mA             | r      | 0             |
| AverageCurrent()         | 0x0b              | Returns a rolling average based upon the last 64 samples of current.  | mA             | r      | 0             |
| MaxError()               | 0x0c              | Returns the expected margin of error.   | percent        | r      | 100           |
| RelativeStateOfCharge()  | 0x0d              | Returns the predicted remaining battery capacity expressed as a percentage of FullChargeCapacity().   | percent        | r      | 0             |
| AbsoluteStateOfCharge()  | 0x0e              | Returns the predicted remaining battery capacity expressed as a percentage of DesignCapacity().   | percent        | r      | 0             |
| RemainingCapacity()      | 0x0f              | Returns the predicted remaining battery capacity.   | mAh            | r      | 0             |
| FullChargeCapacity()     | 0x10              | Returns the predicted battery capacity when fully charged.  | mAh            | r      |               |
| RunTimeToEmpty()         | 0x11              | Returns the predicted remaining battery life at the present rate of discharge.  | minutes        | r      | 65535         |
| AverageTimeToEmpty()     | 0x12              | Returns the rolling average of the predicted remaining battery life.  | minutes        | r      | 65535         |
| AverageTimeToFull()      | 0x13              | Returns the rolling average of the predicted remaining time until the battery reaches full charge.  | minutes        | r      | 65535         |
| ChargingCurrent()        | 0x14              | Returns the battery's desired charging rate.  | mA             | r      | 4000          |
| ChargingVoltage()        | 0x15              | Returns the battery's desired charging voltage.   | mV             | r      | 16800         |
| BatteryStatus()          | 0x16              | Returns the battery's status word.  | Bit flags      | r      | 0x2C0         |
| CycleCount()             | 0x17              | Returns the number of charge/discharge cycles the battery has experienced. A charge/discharge cycle is defined as: an amount of discharge approximately equal to the value of DesignCapacity.                                   | cycles         | r      | 0             |
| DesignCapacity()         | 0x18              | Returns the theoretical capacity of the new battery.  | mAh            | r      | 6600          |
| DesignVoltage()          | 0x19              | Returns the theoretical voltage of a new battery.   | mV             | r      | 14400         |
| SpecificationInfo()      | 0x1a              | Returns the version number of the SBDS the battery pack supports, as well as voltage and current scaling information.   | Formatted word | r      | 0x0031        |
| ManufacturerDate()       | 0x1b              | Returns the date the electronics were manufactured.   | Formatted word | r      |               |
| SerialNumber()           | 0x1c              | Returns the electronics serial number.  | number         | r      |               |
| Reserved                 | 0x1d<br>-<br>0x1f |   |                | r      |               |
| ManufacturerName()       | 0x20              | Returns a character array containing the manufacture's name.  | string         | r      | INSPIREDE     |
| DeviceName()             | 0x21              | Returns a character array that contains the battery's name.   | string         | r      | NL2024ED22    |
| DeviceChemistry()        | 0x22              | Returns a character array that contains the battery's chemistry.  | string         | r      | LION          |
| ManufacturerData()       | 0x23              | Returns data specific to the manufacture.   |                | r      |               |



|                        |              |
|------------------------|--------------|
| Specification Number   | DSNL2024ED22 |
| Specification Revision | 3.1          |
| Prepared By            | JAB          |
| Issue date             | 1/26/16      |

## Battery Specification

### 3.3.8. Battery To Charger Messages (Master Mode)

The battery, acting in the role of a bus master, uses the write word protocol to communicate with the charger, operating in slave mode. If the CHARGER\_MODE bit in BatteryMode() is clear, the Battery will broadcast Charger request information every 10 to 60 second.

#### Battery-to-Charger Messages

| Function          | Command Code | Description   | Unit | Access |
|-------------------|--------------|---|------|--------|
| ChargingCurrent() | 0x14         | Sends the desired charging rate to the battery charger    | mA   | W      |
| ChargingVoltage() | 0x15         | Sends the desired charging voltage to the battery charger | mV   | W      |

### 3.3.9. Critical Messages (Master Mode)

Whenever the Battery detects a critical condition, it takes the role of a bus master and sends AlarmWarning() message to the Host and/ or Charger. The Battery broadcasts the AlarmWarning() message at 10 second intervals until the critical condition(s) has been corrected.

#### Battery Critical Messages

| Function       | Command Code | Description  | Unit           | Access |
|----------------|--------------|--|----------------|--------|
| AlarmWarning() | 0x16         | This message is to the host and/or charger to notify them that one or more alarm conditions exist. | Formatted word | W      |



|                        |              |
|------------------------|--------------|
| Specification Number   | DSNL2024ED22 |
| Specification Revision | 3.1          |
| Prepared By            | JAB          |
| Issue date             | 1/26/16      |

## Battery Specification

### Alarm Bit Definitions

| Bit | Battery Status                             | Set When:  | Action When Set:  | Cleared When:   |
|-----|--|--|---|---|
| 15  | OVER_CHARGD_ALARM                          | RemainingCapacity() exceeds <b>FullChargeCapacity() + 300mAh.</b>  | Stop charging.  | A continuous discharge of $\geq 300\text{mAh}$ .  |
| 14  | TERMINATE_CHARGE_ALARM                     | Primary Charge Termination, Cell or (COV), Over-Current Charge (OCC), Over-Temp Charge (OTC) conditions.<br>COV = 4300mV<br>OCC = 4250mA<br>OTC = 58°C                             | Stop charging.  | RelativeStateOfCharge() $\leq 95\%$ ,<br>COV, OCC or OTC recovery threshold.<br>COV recovery $\leq 4150\text{mV}$<br>OCC recovery $\leq 200\text{mA}$ for 70sec<br>OTC recovery $\leq 56^\circ\text{C}$ |
| 13  | Reserved                                   |  |   |   |
| 12  | OVER_TEMP_ALARM                            | Over-Temp Charge (OTC) or Over-Temp discharge (OTD) condition.<br>OTC=58°C<br>OTD=75°C   | Appropriate FET will be disabled to prevent further action. | OTC or OTD recovery threshold.<br>OTC recovery = 56°C<br>OTD recovery = 65°C  |
| 11  | TERMINATE_DISCHARGE_ALARM                  | RelativeStateOfCharge() $\leq 0\%$ , Cell Under-Voltage (CUV), Over-Current Discharge (OCD), Over-Temp Discharge (OTD) conditions.<br>CUV = 2500mV<br>OCD = -10000mA<br>OTD = 75°C | Stop discharging.   | RelativeStateOfCharge() $\geq 1\%$ ,<br>CUV, OCD or OTD recovery threshold.<br>CUV recovery $\geq 3000\text{mV}$<br>OCD recovery $\geq -200\text{mA}$ for 70sec<br>OTD recovery $\leq 65^\circ\text{C}$ |
| 10  | Reserved                                   |  |   |   |
| 9   | REMAINING_CAPACITY_ALARM ( User settable ) | RemainingCapacity() < RemainingCapacityAlarm().  | User defined.   | RemainingCapacityAlarm() = 0 or is $\leq$ RemainingCapacity().  |
| 8   | REMAINING_TIME_ALARM ( User settable )     | AverageTimeToEmpty() < RemainingTimeAlarm().   | User defined.   | RemainingTimeAlarm() = 0 or $\leq$ AverageTimeToEmpty().  |

### Status Bit Definitions

| Bit | Battery Status   | Set When:  | Action When Set:  | Cleared When:                         |
|-----|------------------|--|-------------------|---------------------------------------|
| 7   | INITIALIZED      |  | None.             |                                       |
| 6   | DISCHARGING      | Battery is not in charge mode.                         | None.             | Battery is in charging mode.          |
| 5   | FULLY CHARGED    | When the battery detects a primary charge termination. | Stop charging.    | RelativeStateOfCharge() $\leq 95\%$ . |
| 4   | FULLY DISCHARGED | RelativeStateOfCharge() $\leq 0\%$ .                   | Stop discharging. | RelativeStateOfCharge() $\geq 20\%$ . |

### 3.3.10.Pack Calibration Cycle

The fuel-gauge uses the Impedance Track Technology to measure and calculate the available charge in battery cells. The achievable accuracy is better than 1% error over the lifetime of the battery. Max Error increases by 1% in 20 cycles, e.g., only occasionally is a full charge/discharge learning cycle required to maintain high accuracy.

## 3.4. Protection Electronics

### 3.4.1. Overview Of Operation

Electronic circuitry is permanently connected within the battery pack to prevent damage if either the charger or host device fails to function correctly. The circuitry also protects the battery if an illegal current source is placed across the battery terminals, or an illegal load is connected. Redundant levels of protection have been implemented (the primary protection levels are auto-resettable and the secondary are non-resettable ).





|                        |              |
|------------------------|--------------|
| Specification Number   | DSNL2024ED22 |
| Specification Revision | 3.1          |
| Prepared By            | JAB          |
| Issue date             | 1/26/16      |

## Battery Specification

### 3.4.2. Charge Protection

#### Over-Voltage:

The primary protection circuit will prevent the battery from charging if any cell voltage  $\geq 4300\text{mV}$ . Then, once all cell voltages are  $\leq 4150\text{mV}$ , it will allow charging again.

The secondary protection circuit will prevent the battery from charging if any cell voltage  $\geq 4.45\text{V} \pm 0.05\text{V}$  by blowing a power path logic fuse. The fuse is non-re-settable rendering the battery pack non-functional.

#### Over-temp:

The primary protection circuit also provides over-temperature protection and will prevent the battery from charging at temperatures  $\geq 54^\circ\text{C}$  (see paragraph 3.1.5 for ChargeCurrent() request). Then, once the battery temperature has cooled to  $\leq 45^\circ\text{C}$ , it will again allow charging.

#### Over-Current:

The primary protection circuit also provides continuous over-current protection and will prevent the battery from charging at Current()  $\geq 4.25\text{A}$ . Then, once the AverageCurrent()  $\leq 200\text{mA}$  for 70sec, the battery will re-test the over-current condition, and again allow charging.

### 3.4.3. Discharge Protection

#### Under-Voltage:

The primary protection circuit will prevent the battery from being further discharged once any cell voltage reaches  $\leq 2500\text{mV}$ . Then, once all cell voltages are  $\geq 3000\text{mV}$ , it will allow discharge again.

#### Over-temp:

The primary protection circuit also provides over-temperature protection and will prevent the battery from discharging at temperatures  $\geq 75^\circ\text{C}$ . Then, once the battery temperature has cooled to  $\leq 65^\circ\text{C}$ , it will again allow discharging.

If the battery reaches  $85^\circ\text{C}$  for any reason the secondary protection circuit will blow the in-line power path logic fuse. The fuse is non-re-settable rendering the battery pack non-functional.

#### Over-Current:

The primary protection circuit also provides continuous over-current protection and will prevent the battery from discharging at Current()  $\leq -10.00\text{A}$ . Then, Once the AverageCurrent()  $\geq -200\text{mA}$  for 70sec, the battery will re-test the over-current condition, and again allow discharging.

### 3.4.4. Short-Circuit Protection

The primary protection circuit will prohibit the discharge of the battery if a short-circuit is placed across the battery + / - terminals. Then, once the AverageCurrent()  $\geq -1\text{mA}$  for 70sec, the battery will re-test the short-circuit condition, and again allow discharging.

|                        |              |
|------------------------|--------------|
| Specification Number   | DSNL2024ED22 |
| Specification Revision | 3.1          |
| Prepared By            | JAB          |
| Issue date             | 1/26/16      |

## Battery Specification

The pack is design to withstand reasonable in-rush currents without resetting the electronics and without interrupting the discharge cycle. The following graph illustrates the short-circuit/in-rush set points as implemented:

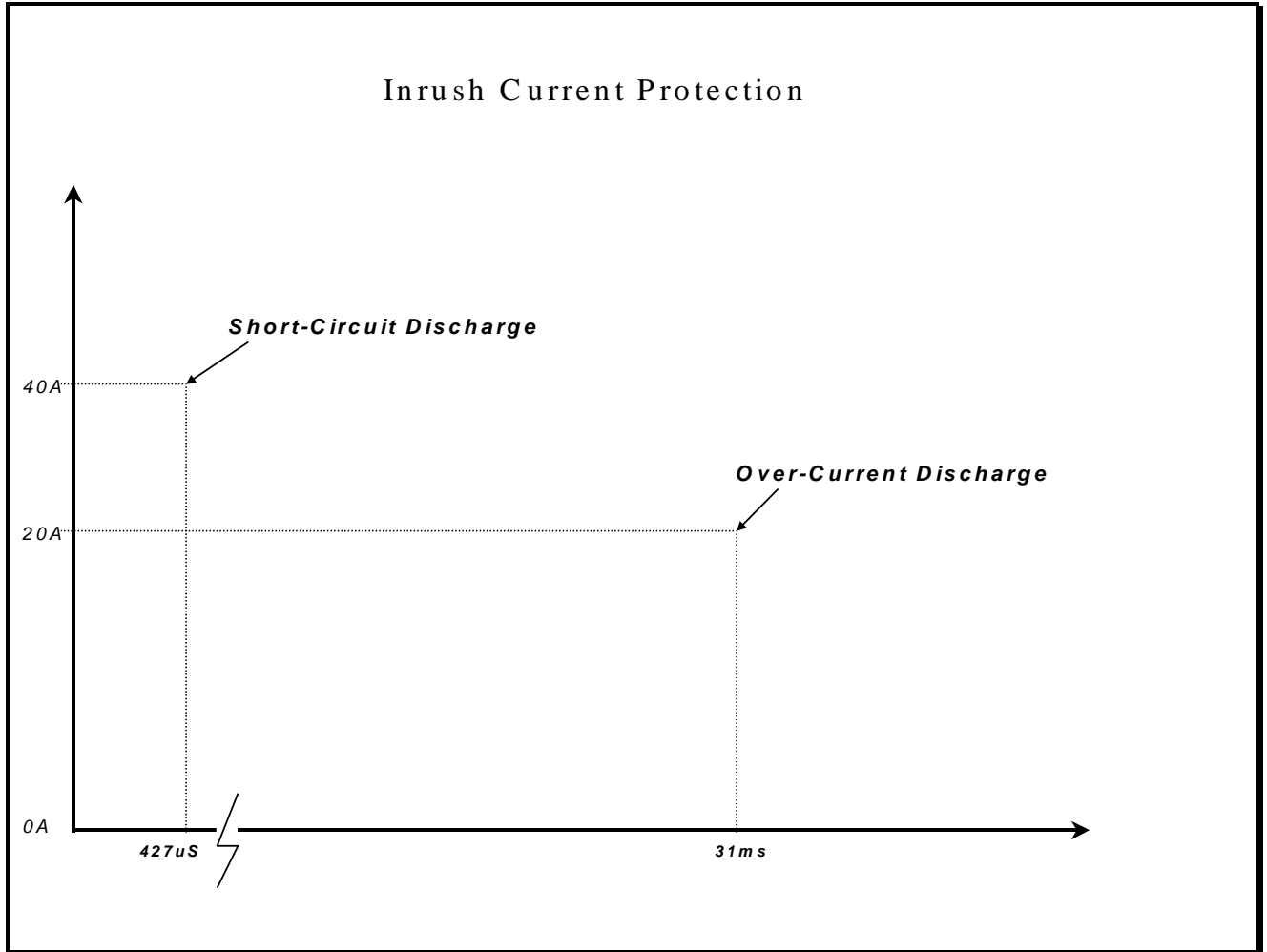

### 3.5. Passive Safety Protection

#### 3.5.1. Overview Of Operation

The battery pack is fitted with additional components to protect it against abusive charge and discharge conditions. These are in addition to the electronic protection.



|                        |              |
|------------------------|--------------|
| Specification Number   | DSNL2024ED22 |
| Specification Revision | 3.1          |
| Prepared By            | JAB          |
| Issue date             | 1/26/16      |

## Battery Specification

### 3.5.2. Thermal Fuse

A Thermal Fuse is fitted in series with the charge/ discharge path to protect the battery from over temperature. This device goes open circuit if the cell case temperature reaches the fuse's temperature rating of 93°C (+0°C, -5°C). The fuse is non-re-settable rendering the battery pack non-functional.

### 3.5.3. Slow-Blow Current Fuse (Logic Fuse)

A current slow-blow fuse is assembled in series with the battery pack to protect the battery pack against abusive over current over-load. The hold current is rated at 15A for 4 hours (minimum@25C). The fuse is non-re-settable rendering the battery pack non-functional.

## 3.6. Mechanical Specifications

### 3.6.1. Weight

Approximately 1.426lbs. (0.647Kg).

### 3.6.2. Mating Connector

The recommended interconnection mating male connector is AMP P/N 5787422-1 or 5787446-1.

### 3.6.3. Date Code/Serial Number

IE YYWWRR

SN SSSSS XZZWh

IE = Inspired Energy Newberry facility

YY = Calendar Year

WW = Calendar Week

RR = Battery revision

SSSSS = Serial Number

X = the cell supplier

ZZWh = the stored energy of the battery in Watt hours

### 3.6.4. Packaging

The batteries are packaged in bulk, with 12 batteries per carton.



## Battery Specification

|                        |              |
|------------------------|--------------|
| Specification Number   | DSNL2024ED22 |
| Specification Revision | 3.1          |
| Prepared By            | JAB          |
| Issue date             | 1/26/16      |

### 3.6.5. Mechanical Drawing

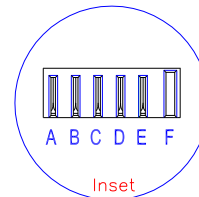

Inset

- Terminals
- A - Negative
  - B - Temperature
  - C - Data
  - D - Clock
  - E - Positive
  - F - Key



|                        |              |
|------------------------|--------------|
| Specification Number   | DSNL2024ED22 |
| Specification Revision | 3.1          |
| Prepared By            | JAB          |
| Issue date             | 1/26/16      |

## Battery Specification

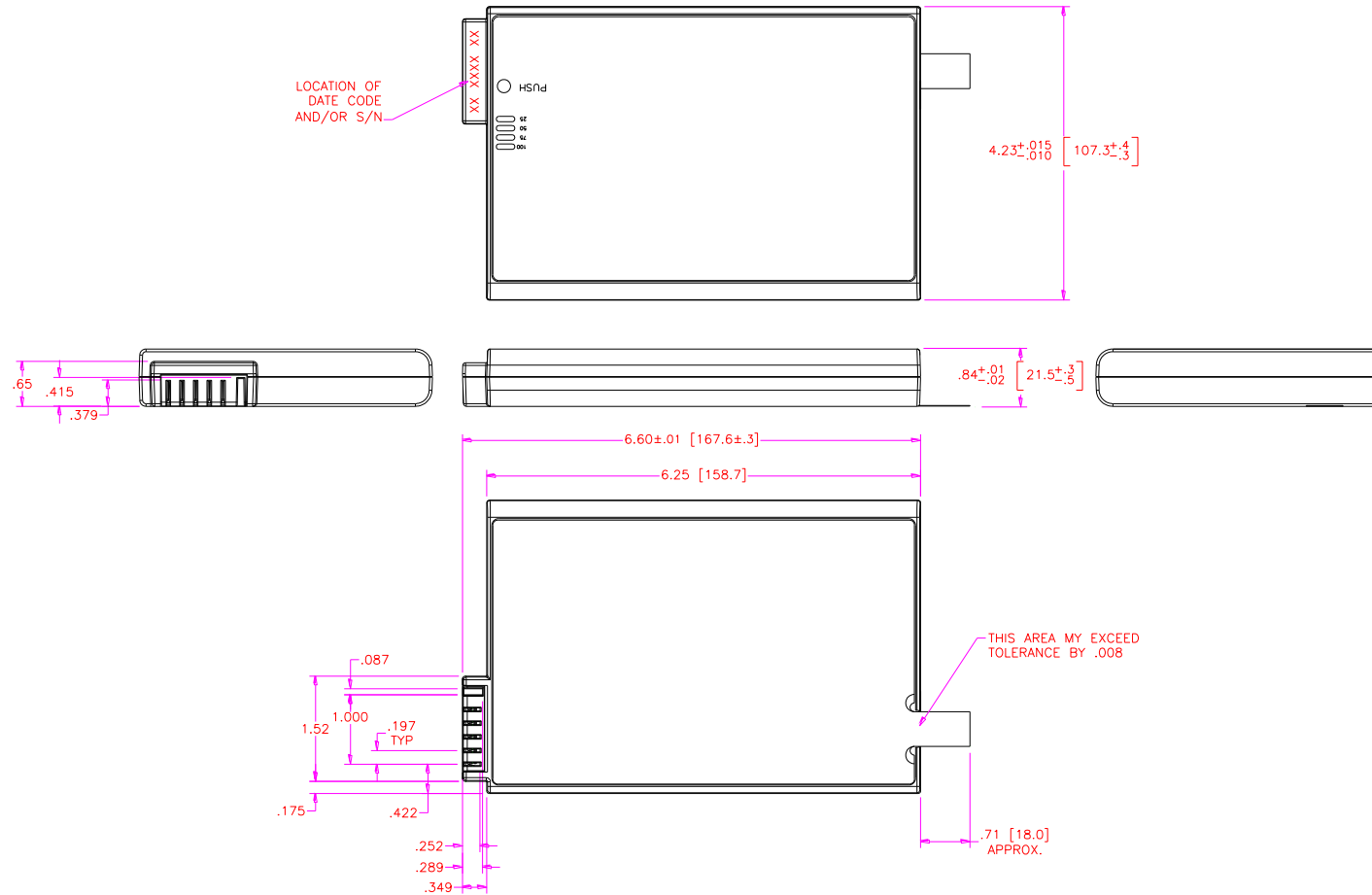



|                        |              |
|------------------------|--------------|
| Specification Number   | DSNL2024ED22 |
| Specification Revision | 3.1          |
| Prepared By            | JAB          |
| Issue date             | 1/26/16      |

## Battery Specification

### 3.7. Environmental/Safety Specifications

#### 3.7.1. EMC And Safety

The battery complies with the following:

- EMC Directive 2004/108/EC
- Low Voltage Directive 2006/95/EC
- Battery Recycling Directive 2006/66/EC as amended
- “RoHS“ Directive 2011/65/EU

The battery has been tested in accordance with the UN Manual of tests and Criteria part III subsection 38.3 (ST/SG/AC.10/11/Rev.3) - more commonly known as the UN T1-T8 Transportation tests; and has been found to comply with the stated criteria. [USDOT-E7052]

The battery has the following approvals and the pack will be labeled according:

- CE [EN55022:2006 (ITE Class B) & EN55024:1998 (ITE)]
- FCC Part 15 Class B

### 3.8. Reliability

#### 3.8.1. Life Expectancy

Given normal storage & usage, user can expect the battery to deliver 80% or more of it's initial capacity after 300 charge/discharge cycles where the charge phase is CC/CV 1320mA, 16.8±0.05V and the discharge is 4000mA down to 2.9V/Cell at 25°C.

#### 3.8.2. Warranty

Inspired Energy maintains a high quality standard. All products are warranted against defects in workmanship, material and construction. The warranty period is one (1) year from the date of shipment from Inspired Energy.

#### 3.8.3. Shelf Life

The batteries are shipped from Inspired Energy with between 20% and 30% rated capacity and this provides a minimum of 6 months shelf life, when stored at 25°C. If the storage temperature exceeds 25°C over the 6-month period then the shelf life will be reduced and provisions should be made to recharge the battery periodically.

In order to prevent parasitic drain on the battery, the electronics will go into a shutdown mode if any cell voltage ≤ 2300mV. If this should happen, the battery pack will require an initial low charge to activate the electronics prior to the implementation of the normal charge. Any SMBus version 1.0, or higher, compatible charger is capable of providing this initial pre-charge.