

Battery Specification

Document Number & Revision

DS153HD26

Description

Rechargeable Smart Lithium Ion Battery Pack

Inspired Energy Part Number For Battery

NI2020HD26

Statement Of Confidentiality

The information contained within this document is confidential and proprietary to Inspired Energy. This information should not, in whole or in part, be reproduced, disclosed or used except as expressly and duly authorized by Inspired Energy.

This information is descriptive only. No representation, guarantee or warranty of merchantability or fitness for purpose is made or implied. Specifications are subject to change without notice.



Specification Number	DS153HD26
Specification Revision	1.0
Prepared By	RAH
Issue date	4/25/08

Battery Specification

TABLE OF CONTENTS

1. REVISION HISTORY	4
2. INTRODUCTION	4
2.1. SCOPE	4
2.2. BATTERY PACK OVERVIEW.....	4
2.3. GENERAL PRECAUTIONS.....	5
2.3.1. <i>Handling</i>	5
2.3.2. <i>Charge & Discharge</i>	5
2.3.3. <i>Storage</i>	5
2.3.4. <i>Disposal</i>	5
3. REQUIREMENTS	5
3.1. GENERAL REQUIREMENTS	5
3.1.1. <i>Nominal Voltage</i>	5
3.1.2. <i>Rated Capacity</i>	5
3.1.3. <i>Initial Impedance</i>	6
3.1.4. <i>Discharge</i>	6
3.1.5. <i>Charge</i>	7
3.1.6. <i>Storage</i>	7
3.1.7. <i>Terminal Specifications</i>	8
3.2. FUEL-GAUGE ELECTRONICS	8
3.2.1. <i>Overview Of Operation</i>	8
3.2.2. <i>DC Specifications</i>	9
3.2.3. <i>Measurement Accuracy</i>	10
3.2.3.1. <i>Voltage</i>	10
3.2.3.2. <i>Temperature</i>	10
3.2.3.3. <i>Current</i>	10
3.2.4. <i>LED Indication</i>	10
3.3. SMBUS AND SBD PARAMETERS	11
3.3.1. <i>Overview Of Operations</i>	11
3.3.2. <i>SMBus Logic Levels</i>	11
3.3.3. <i>Communication Protocol</i>	11
3.3.4. <i>Initialization Procedure</i>	11
3.3.4.1. <i>Write Word</i>	12
3.3.4.2. <i>Read Word</i>	12
3.3.4.3. <i>Block Read</i>	12
3.3.5. <i>Communicating with the Host</i>	12
3.3.6. <i>Host To Battery Message (Slave Mode)</i>	12
3.3.7. <i>Battery To Charger Messages (Master Mode)</i>	12
3.3.8. <i>Critical Messages (Master Mode)</i>	12
3.3.9. <i>Definition Of Valid Calibration Cycle</i>	12
3.4. PROTECTION ELECTRONICS	12
3.4.1. <i>Overview Of Operation</i>	12
3.4.2. <i>Over-Charge Protection</i>	12
3.4.3. <i>Over-Discharge Protection</i>	12



Specification Number	DS153HD26
Specification Revision	1.0
Prepared By	RAH
Issue date	4/25/08

Battery Specification

3.4.4.	<i>Over-Current Protection</i>	12
3.5.	PASSIVE SAFETY PROTECTION	12
3.5.1.	<i>Overview Of Operation</i>	12
3.5.2.	<i>Thermal Fuse</i>	12
3.5.3.	<i>Slow-Blow Current Fuse</i>	12
3.6.	MECHANICAL SPECIFICATIONS.....	12
3.6.1.	<i>Weight</i>	12
3.6.2.	<i>Mating Connector</i>	12
3.6.3.	<i>Date Code/Serial Number</i>	12
3.6.4.	<i>Packaging</i>	12
3.6.5.	<i>Mechanical Drawing</i>	12
3.7.	ENVIRONMENTAL/SAFETY SPECIFICATIONS	12
3.7.1.	<i>EMC And Safety</i>	12
3.8.	RELIABILITY	12
3.8.1.	<i>Life Expectancy</i>	12
3.8.2.	<i>Warranty</i>	12
3.8.3.	<i>Shelf Life</i>	12



Specification Number	DS153HD26
Specification Revision	1.0
Prepared By	RAH
Issue date	4/25/08

Battery Specification

1. REVISION HISTORY

Revision	Release Date	Revisions	Issued By	Approved By
1.0	5/28/08	Initial release. Cell Capacity 2600mAh.	RAH	DB

2. INTRODUCTION

2.1. Scope

This specification describes the physical, functional and electrical characteristics of a rechargeable Lithium Ion battery pack supplied by Inspired Energy. This specification is the interface document between Inspired Energy and it's customers. It is understood that the customer may create their own internal specification. However, this specification is the master that defines the battery's operation. Battery packs produced will meet this specification.

2.2. Battery Pack Overview

This specification describes the physical, functional and electrical requirements for the NI2020HD Smart Battery including a rechargeable Lithium Ion battery and a Battery Management Module. The battery consists of (9) Lithium Ion rechargeable cells of 18650 size, assembled in a 3 series / 3 parallel (3S 3P) configuration. Each cell has an average voltage of 3.6V and a typical capacity of 2.6Ah giving a battery pack of 10.8V and 7.8Ah typical.

The battery is capable of communicating with host or the charger through the System Management Bus (SMBus). The battery is fully SMBus and SBDS Revision 1.1 w/o packet-error-checking (PEC) compliant. Protection is provided for over-charge, over-discharge and short circuit. For redundancy, passive safety devices have been integrated into the pack to protect against over-current and over-temperature.

The battery pack comprises the individual elements as shown below.

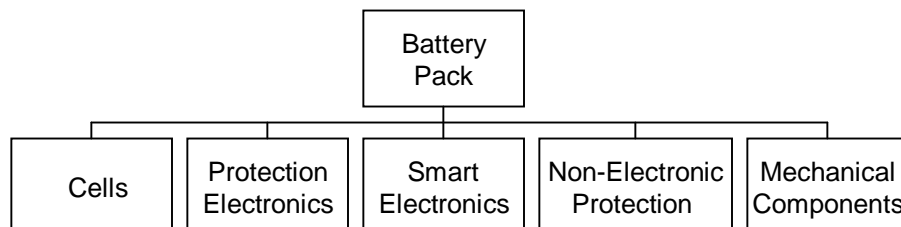



Specification Number	DS153HD26
Specification Revision	1.0
Prepared By	RAH
Issue date	4/25/08

Battery Specification

2.3. General Precautions

2.3.1. Handling

- Avoid shorting the battery
- Do not immerse in water.
- Do not disassemble or deform the battery
- Do not expose to, or dispose of the battery in fire.
- Avoid excessive physical shock or vibration.
- Keep out of the reach of children.
- Never use a battery that appears to have suffered abuse.

2.3.2. Charge & Discharge

- Battery must be charged in appropriate charger only.
- Never use a modified or damaged charger.
- Specified product use only.

2.3.3. Storage

- Store in a cool, dry and well-ventilated area.

2.3.4. Disposal

- Regulations vary for different countries. Dispose of in accordance with local regulations.

3. REQUIREMENTS

3.1. General Requirements

3.1.1. Nominal Voltage

The battery nominal operating voltage is 10.8V.

3.1.2. Rated Capacity

The initial capacity is $\geq 7410\text{mAh}$ (based on a CV charge of $12.6\text{V} \pm 50\text{mV}$ with a current limit of 3A and a 1560mA discharge to 8.25V @ 25C, within 1 hour of charge).



Specification Number	DS153HD26
Specification Revision	1.0
Prepared By	RAH
Issue date	4/25/08

Battery Specification

3.1.3. Initial Impedance

The internal impedance of a fully charged battery shall be $< 200\text{m}\Omega$ when measured across the positive and negative battery terminals at 1kHz at 20°C.

3.1.4. Discharge

Discharge Temperature Limits: -10°C to 50°C , $\leq 80\% \text{RH}$

The battery shall be capable of continuous discharge within the Pack Operating Boundary as shown in the graph below.

Host devices should be designed for a controlled shutdown following battery notification of termination by the battery sending TERMINATE_DISCHARGE alarm, prior to protection circuit cut-off.

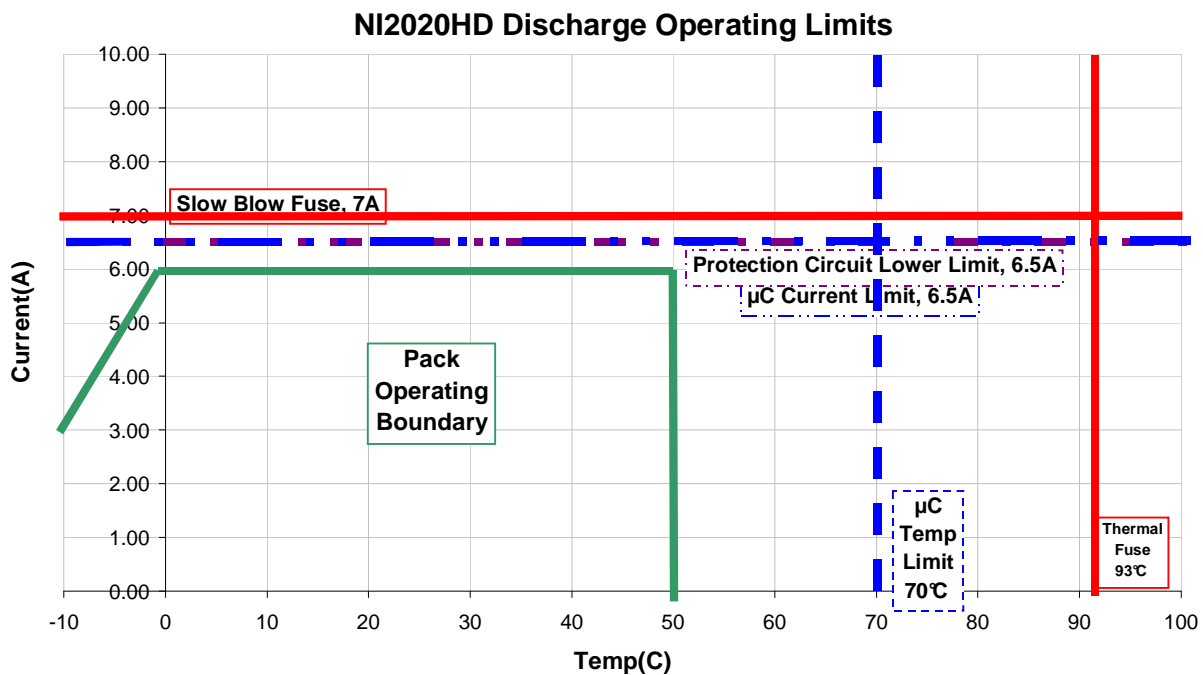

The FULLY_DISCHARGED bit in the BatteryStatus() will be set when a parallel-cell-group's voltage drops below 2.9V.



Specification Number	DS153HD26
Specification Revision	1.0
Prepared By	RAH
Issue date	4/25/08

Battery Specification

3.1.5. Charge

Charge Temperature Limits: 0°C to 45°C, ≤ 80%RH

The battery shall be capable of continuous charge at 12.6V, 3.0A across the entire charge temperature range. A dedicated level II or level III smart battery charger is required to charge the battery. Using this type of charger, the battery will request appropriate charging Voltage and Current from the smart battery charger.

The FULLY_CHARGED bit in the BatteryStatus() will be set when the charging current tapers down under 260mA while charging at 12.6V.

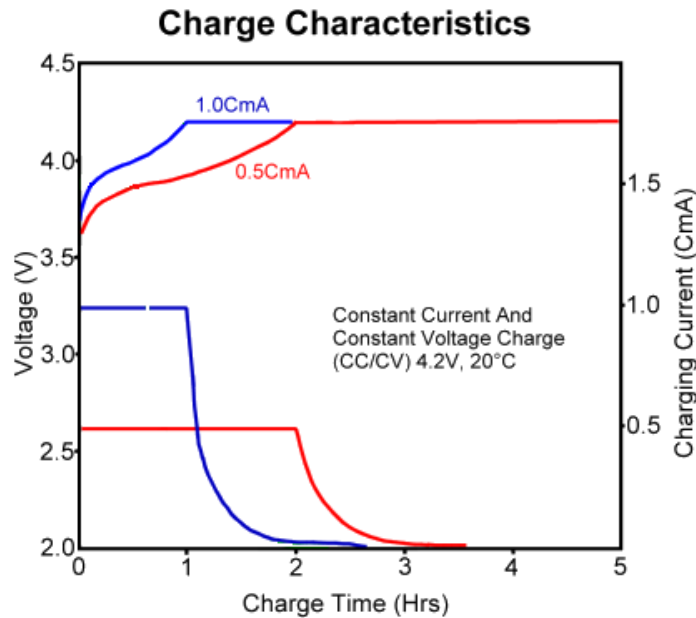

3.1.6. Storage

Storage Temperature Limits: -20°C to 60°C, ≤ 80%RH

The battery packs should be stored in an environment with low humidity, free from corrosive gas at a recommended temperature range <21°C. Extended exposure to temperatures above 45°C could degrade battery performance and life.



Specification Number	DS153HD26
Specification Revision	1.0
Prepared By	RAH
Issue date	4/25/08

Battery Specification

3.1.7. Terminal Specifications

See Mechanical Drawing for orientation of contacts J1-1,5

Terminal	Legend	Description
1	(+)	Positive side of battery
2	(C)	SMBus Clock. Internally a 1M Ω resistor is connected between (C) and (-).
3	(D)	SMBus Data. Internally a 1M Ω resistor is connected between (D) and (-).
4	(T)	300 Ω \pm 5% resistor connected between (T) and (-).
5	(-)	Negative Side Of Battery

- A key slot is also present on each pack for mechanical alignment adjacent to the positive terminal.
- The SMBus Clock and data lines require separate pull-ups to system logic voltage, NOT the battery voltage. Typically a 15K Ω pull-up resistor is used, but please refer to the SMBus Specification for additional information.

3.2. Fuel-Gauge Electronics

3.2.1. Overview Of Operation

The battery is capable of communicating with host or the charger through the System Management Bus (SMBus). The battery is fully SMBus and SBDS Revision 1.1 w/o PEC compliant. An 8-bit Reduced Instruction Set CPU (RISC) is used to process the core algorithms and perform operations required for battery monitoring. Charge and discharge current, cell and pack voltages, and pack temperature are all measured using an integrated analog to digital converter at 12-bit to 14-bit effective resolution depending on the measurement.

Protection circuits for over-charge, over-discharge and short-circuit are also included, as well as passive safety devices for short-circuit and thermal protection.

The battery pack uses a system level approach to optimize the performance of the battery. It's primary functions are to provide fuel gauging and software based charge control, and to ensure safe operation throughout the life cycle of the battery.

The fuel gauge determines the State-Of-Charge (SOC) by integrating the input and output current of the attached battery. To achieve the desired fuel-gauging accuracy, compensation factors are continually applied to account for battery non-linearity and environmental conditions. This approach provides the user a meaningful and repeatable capacity measure with minimal risk of overstating run time. Visually, the SOC can be obtained from the four on-pack LED's with push-button activation.

Charge control is used to provide optimal and safe charging requests to an SMBus level II or level III charger.

Specification Number	DS153HD26
Specification Revision	1.0
Prepared By	RAH
Issue date	4/25/08

Battery Specification

The system has three modes of operation; active, standby and shutdown. Standby mode is entered when the system senses no host or charger present for at least 10 seconds. While in this mode, battery parameters continue to be monitored at regular intervals to compensate for self-discharge capacity losses. The system will continue in this mode until it senses host activity (communications or current flow). Shutdown mode occurs when the battery voltage falls below 2.4V/parallel cell group. In this mode, parasitic current is reduced to a minimum by shutting down the micro-controller and all associated circuitry. If this should happen, the battery will require an initial low current charge to bring the battery voltage back up before normal operation will resume.

The battery pack block diagram is shown below.

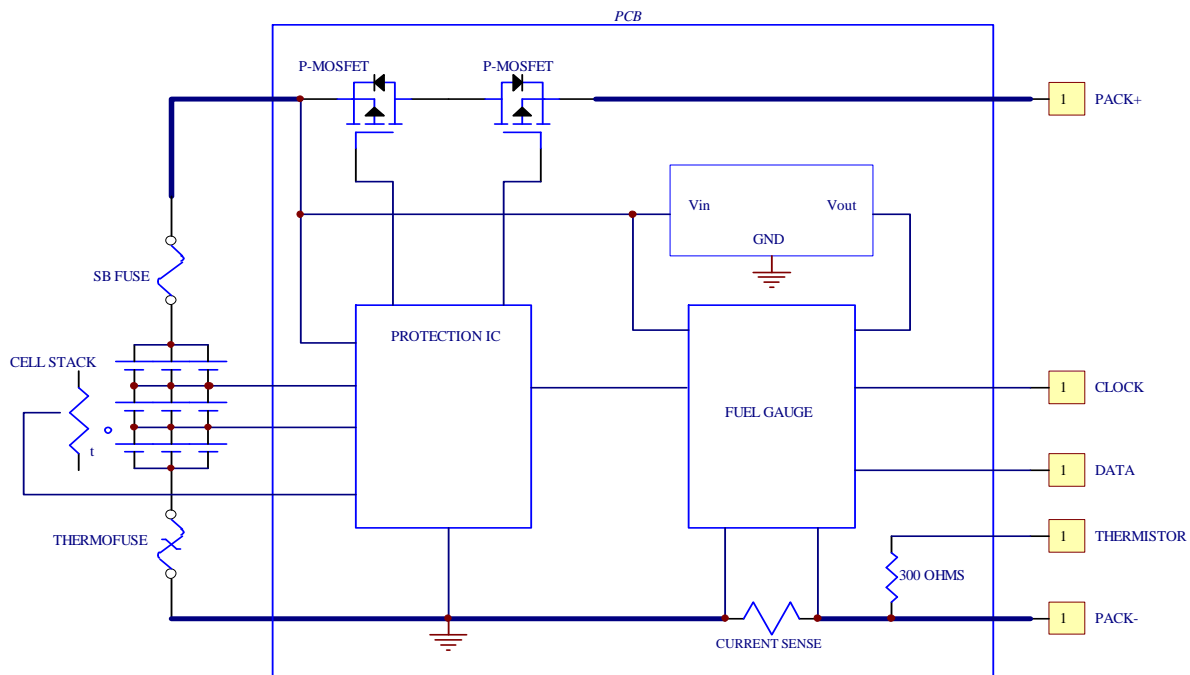

3.2.2. DC Specifications

Parameter	Limits	Remarks
Active mode current consumption	<1.4mA	When a host is detected (charging, discharging or communications).
Standby mode current consumption	<220uA	When no host activity is detected.
Shut-down mode current consumption	<1uA	Battery voltage falls below 2.4±.08V/parallel-cell-group. Normal operation resumes when the battery voltage returns to a level 0.2±0.1V above the shutdown level



Specification Number	DS153HD26
Specification Revision	1.0
Prepared By	RAH
Issue date	4/25/08

Battery Specification

3.2.3. Measurement Accuracy

3.2.3.1. Voltage

The voltage measurements have a resolution of 1mV. The absolute accuracy of the reading is $\pm 1\%$ over the operating range. Note that measurements are made at the cell stack (not the pack connector). Therefore internal resistance drops due to the shunt, safety components, and contact resistance are not taken into consideration.

3.2.3.2. Temperature

The internal pack temperature is measured by a on-chip temperature sensor in thermal contact with the cell stack. Temperature readings have a resolution of 0.1°K. The absolute accuracy is $\pm 3^\circ\text{K}$ over an operating range of 0°C to +50°C.

3.2.3.3. Current

The current measurements have a resolution of 1mA. The absolute accuracy of the reading is $\pm 2.0\%$ or $\pm 8\text{mA}$ whichever is greater over the operating range. A guard band has been imposed around zero current (-15mA to +15mA).

3.2.4. LED Indication

The battery can directly display the capacity information. The battery capacity is displayed as the relative SOC. Each LED segment represents 25 percent of the full charge capacity. The LED pattern definition is given in the table below. The LED's illuminate for 5 seconds following switch activation. If the battery voltage is below 5.5V, there will be no LED indication.

Capacity	LED Indicators #				Note
	1	2	3	4	
At or below 10%					Blinks 3 times.
10% - 25%					Lit for 5 seconds.
26% - 50%					Lit for 5 seconds.
51% - 75%					Lit for 5 seconds.
76% - 100%					Lit for 5 seconds.



Specification Number	DS153HD26
Specification Revision	1.0
Prepared By	RAH
Issue date	4/25/08

Battery Specification

3.3. SMBus and SBD Parameters

3.3.1. Overview Of Operations

The battery is fitted with a microprocessor and associated circuitry for communication with an external host device and/or smart battery charger. Reference should be made to the following specifications when reading this section:

- System Management Bus Specification (Rev 1.1, Dec 11, 1998)
- Smart Battery Data Specification (Rev 1.1, Dec 15, 1998)
- Smart battery Charger Specification (Rev 1.0, June 27, 1996)

3.3.2. SMBus Logic Levels

Symbol	Parameter	Limits		Units
		Min	Max	
Vil	Data/Clock input low voltage		0.6	V
Vih	Data/Clock input high voltage	1.4	5.5	V
Vol			0.4	V

3.3.3. Communication Protocol

SMBus Interface complies with SBS Specification Version 1.1 w/o PEC. The battery pack includes a simple bi-directional serial data interface. A host processor uses the interface to access various battery pack registers.

3.3.4. Initialization Procedure

The interface uses a command-based protocol, where the host processor sends the battery address command byte to the battery pack. The command directs the battery pack to either store the next data received to a register specified command byte or output the data specified by the command byte.

The Bus Host communicates with the battery pack using one of three protocols:

- Write Word
- Read Word
- Read Block



Specification Number	DS153HD26
Specification Revision	1.0
Prepared By	RAH
Issue date	4/25/08

Battery Specification

3.3.4.1. Write Word

The first byte of a Write Word access is the command code. The next two Bytes are the data to be written. In this example the master asserts the slave device address followed by the write bit. The device acknowledges and the master delivers the command code. The slave again acknowledges before the master sends the data word (low byte first). The slave acknowledges each byte according to the I²C specification, and the entire transaction is finished with a stop condition.

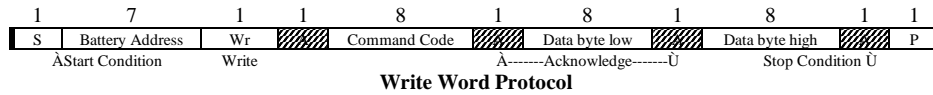

□ SMBus Host (master) ▨ Smart Battery (slave)

3.3.4.2. Read Word

Reading data is slightly more complex than writing data. First the host must write a command to the slave device. Then it must follow that command with a repeated start condition to denote a read from that device's address. The slave then returns two bytes of data.

Note that there is not a stop condition before the repeated start condition, and that a "Not Acknowledge" signifies the end of the read transfer.

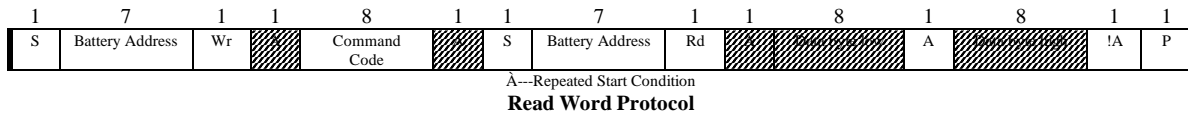

□ SMBus Host (master) ▨ Smart Battery (slave)

3.3.4.3. Block Read

The Block Read begins with a slave address and a write condition. Then it must follow that command with a repeated start condition to denote a read from that device's address. After the repeated start the slave issues a byte count that describes how many data bytes will follow in the message. If a slave had 20 bytes to send, the first byte would be the number 20 (14h), followed by the 20 bytes of data. The byte count may not be 0. A Block Read can transfer a maximum of 32 bytes.

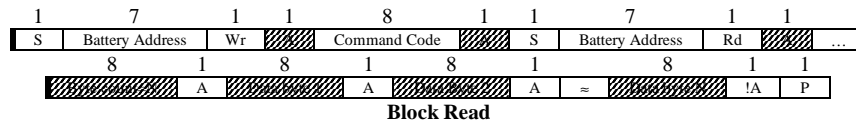

□ SMBus Host (master) ▨ Smart Battery (slave)



Specification Number	DS153HD26
Specification Revision	1.0
Prepared By	RAH
Issue date	4/25/08

Battery Specification

3.3.5. Communicating with the Host

A message destined for the host could appear from an unknown device in an unknown format. To prevent possible confusion on the host part, only one method of communication is allowed -- a modified Write Word. This protocol is used when an SMBus device becomes a master to communicate with the SMBus host acting as a slave.

Device to Host communication will begin with the host address. The message's Command Code will actually be the initiating device's address. The host now knows the origin of the following 16 bits of device status.



Smart Battery (master)
 Smart Battery Charger (slave)

Note : For the detail and the latest information, please refer to the Web Site address : “www.sbs-forum.org”

3.3.6. Host To Battery Message (Slave Mode)

The Host acting in the role of bus master uses the read word, write word, and read block protocols to communicate with the battery, operating in slave mode.



Specification Number	DS153HD26
Specification Revision	1.0
Prepared By	RAH
Issue date	4/25/08

Battery Specification

Host-to-Battery Messages

Function	Command Code	Description	Unit	Access	Default (POR)
ManufacturerAccess()	0x00			r/w	
RemainingCapacityAlarm()	0x01	Remaining Capacity Alarm Threshold .	mAh	r/w	780
RemainingTimeAlarm()	0x02	Remaining Time Alarm Threshold.	minutes	r/w	10
BatteryMode()	0x03	Battery Operational Modes.	Bit flags	r/w	0x0080
AtRate()	0x04	This function is the first half of a two-function call-set used to set the AtRate value used in calculations made by the AtRateTimeToFull(), AtRateTimeToEmpty(), and AtRateOK() functions.	mA	r/w	0
AtRateTimeToFull()	0x05	Returns the predicted remaining time to fully charge the battery at the AtRate() value.	minutes	r	65535
AtRateTimeToEmpty()	0x06	Returns the predicted remaining operating time if the battery is discharged at the AtRate() value.	minutes	r	65535
AtRateOK()	0x07	Returns a Boolean value that indicates whether or not the battery can deliver the AtRate value of additional energy for 10 seconds. If the AtRate() value is zero or positive, the AtRateOK() function will ALWAYS return TRUE.	boolean	r	1
Temperature()	0x08	Returns the pack's internal temperature.	0.1 °K	r	
Voltage()	0x09	Returns the battery's voltage (measured at the cell stack)	mV	r	
Current()	0x0a	Returns the current being supplied (or accepted) through the battery's terminals.	mA	r	0
AverageCurrent()	0x0b	Returns a rolling average based upon the last 64 samples of current.	mA	r	0
MaxError()	0x0c	Returns the expected margin of error.	percent	r	10
RelativeStateOfCharge()	0x0d	Returns the predicted remaining battery capacity expressed as a percentage of FullChargeCapacity().	percent	r	0
AbsoluteStateOfCharge()	0x0e	Returns the predicted remaining battery capacity expressed as a percentage of DesignCapacity().	percent	r	0
RemainingCapacity()	0x0f	Returns the predicted remaining battery capacity.	mAh	r	0
FullChargeCapacity()	0x10	Returns the predicted battery capacity when fully charged.	mAh	r	7020
RunTimeToEmpty()	0x11	Returns the predicted remaining battery life at the present rate of discharge.	minutes	r	65535
AverageTimeToEmpty()	0x12	Returns the rolling average of the predicted remaining battery life.	minutes	r	65535
AverageTimeToFull()	0x13	Returns the rolling average of the predicted remaining time until the battery reaches full charge.	minutes	r	65535
ChargingCurrent()	0x14	Returns the battery's desired charging rate.	mA	r	3000
ChargingVoltage()	0x15	Returns the battery's desired charging voltage.	mV	r	12600
BatteryStatus()	0x16	Returns the battery's status word.	Bit flags	r	0x2C0
CycleCount()	0x17	Returns the number of charge/discharge cycles the battery has experienced. A charge/discharge cycle is defined as: an amount of discharge approximately equal to the value of DesignCapacity.	cycles	r	0
DesignCapacity()	0x18	Returns the theoretical capacity of the new battery.	mAh	r	7800
DesignVoltage()	0x19	Returns the theoretical voltage of a new battery.	mV	r	10800
SpecificationInfo()	0x1a	Returns the version number of the SBDS the battery pack supports, as well as voltage and current scaling information.	Formatted word	r	0x0021
ManufacturerDate()	0x1b	Returns the date the electronics was manufactured.	Formatted word	r	
SerialNumber()	0x1c	Returns the electronics serial number.	number	r	
Reserved	0x1d - 0x1f			r	
ManufacturerName()	0x20	Returns a character array containing the manufacture's name.	string	r	INSPIREDE
DeviceName()	0x21	Returns a character array that contains the battery's name.	string	r	NI2020HD
DeviceChemistry()	0x22	Returns a character array that contains the battery's chemistry.	string	r	LION
ManufacturerData()	0x23	Returns data specific to the manufacture.		r	



Specification Number	DS153HD26
Specification Revision	1.0
Prepared By	RAH
Issue date	4/25/08

Battery Specification

3.3.7. Battery To Charger Messages (Master Mode)

The battery, acting in the role of a bus master, uses the write word protocol to communicate with the charger, operating in slave mode. If the CHARGER_MODE bit in BatteryMode() is clear, the Battery will broadcast Charger request information at 15-second intervals.

Battery-to-Charger Messages

Function	Command Code	Description	Unit	Access
ChargingCurrent()	0x14	Sends the desired charging rate to the battery charger	mA	W
ChargingVoltage()	0x15	Sends the desired charging voltage to the battery charger	mV	W

3.3.8. Critical Messages (Master Mode)

Whenever the Battery detects a critical condition, it takes the role of a bus master and sends AlarmWarning() message to the Host and/ or Charger. The Battery broadcasts the AlarmWarning() message at 10 second intervals until the critical condition(s) has been corrected.

Battery Critical Messages

Function	Command Code	Description	Unit	Access
AlarmWarning()	0x16	This message is to the host and/or charger to notify them that one or more alarm conditions exist.	Formatted word	W

Alarm Bit Definitions

Hex	Battery Status	Status	Definition
4000	TERMINATE_CHARGE_ALARM	ON	Battery is requesting 0 ChargingCurrent() and the charger continues to supply current
		OFF	When either condition is removed.
1000	OVER_TEMP_ALARM	ON	If charging and the "Temperature()" >= 54degC or discharging and the "Temperature()">=70C.
		OFF	If charging and the "Temperature()" drops below 46°C or during discharge and the "Temperature()" drops below 65C.
800	TERMINATE_DISCHARGE_ALARM	ON	During discharge when a parallel-cell-group's voltage drops ≤ 2.9V.
		OFF	When either condition is removed.
200	REMAINING_CAPACITY_ALARM (User settable)	ON	Battery detects that its RemainingCapacity() is less than that set by the RemainingCapacityAlarm()
		OFF	Either the value set by the RemainingCapacityAlarm() is lower than the RemainingCapacity() OR when the RemainingCapacity() in increases by charging the battery.
100	REMAINING_TIME_ALARM (User settable)	ON	Battery detects that the estimated remaining time at the present discharge rate is less than that set by the RemainingTimeAlarm()
		OFF	Either the value set by the RemainingTimeAlarm() is lower than the AverageTimeToEmpty() OR when the AverageTimeToEmpty() in increases by charging the battery.



Specification Number	DS153HD26
Specification Revision	1.0
Prepared By	RAH
Issue date	4/25/08

Battery Specification

Status Bit Definitions

80	INITIALIZED	ON	Always
		OFF	
40	DISCHARGING	ON	Battery "Current()" is not positive
		OFF	Battery "Current()" is positive
20	FULLY_CHARGED	ON	When the battery is being charged and "Current()" declines $\leq 260\text{mA}$ and the battery "Voltage()" $\geq 12.372\text{V}$.
		OFF	When the SOC of the battery declines 3% from the "FULLY_CHARGE" detection point.
10	FULLY_DISCHARGED	ON	Any parallel-cell group's voltage is below 2.9V^{**}
		OFF	"RelativeStateOfCharge()" $\geq 20\%$.

Note:

** The host device should initiate a 'Save-To-Disk' action when the battery broadcasts the TERMINATE_DISCHARGE Alarm during discharge.

3.3.9. Definition Of Valid Calibration Cycle

Calibration is the process whereby the battery's fuel gauge is adjusted to maintain an acceptable level of accuracy. This may be necessary if a battery has aged or has been subjected to an unusual usage pattern. A battery can be calibrated by performing the following procedure:

1. Discharge the battery until the TERMINATE_DISCHARGE_ALARM in the BatteryStatus() is set (parallel-cell-group's voltage $\leq 2.9\text{V}$).
2. Charge the battery at 12.6V (as measured across the battery terminals) and with a current limit no greater than 3000mA . Charge the battery until the TERMINATE_CHARGE_ALARM in the BatteryStatus() is set (Current() $\leq 260\text{mA}$). Repeat step 1.

Note, Calibration is invalid if:

- Any Parallel-cell-group's voltage goes below $2.4 \pm 0.08\text{V}$.
- Pack Temperature goes below 15°C or exceeds 60°C during a calibration cycle.
- Accumulative self-discharge is more than 3% of the FullChargeCapacity().

Notes On Calibration And Maximum Error:

Although Inspired Energy's detailed modeling of cell characteristics ensures that the most accurate correction factors are applied to the fuel gauge capacity to compensate for the effects of time, temperature, usage patterns and charge/discharge rates - it is inevitable that the fuel gauge accuracy will drift with time.

The smart electronics only know the actual capacity at two reference points: 'empty' and 'fully charged'. When either of these two points is reached, the predicted capacity is compared with the known capacity and an error factor is calculated (Max Error). It is recommended that the application software recommend to the user that the battery should be calibrated when a pre-determined max error limit is reached (10% for example).

At the completion of the calibration cycle, the CONDITION_FLAG in the BatteryMode() register will be reset.



Specification Number	DS153HD26
Specification Revision	1.0
Prepared By	RAH
Issue date	4/25/08

Battery Specification

3.4. Protection Electronics

3.4.1. Overview Of Operation

Electronic circuitry is permanently connected within the battery pack to prevent damage if either the charger or host device fails to function correctly. The circuitry also protects the battery if an illegal current source is placed across the battery terminals, or an illegal load is connected. The protection circuitry operates completely independent of the micro-controller.

3.4.2. Over-Charge Protection

The protection circuit will prevent the battery from charging at a voltage of $4.35 \pm 0.025V$ or more per parallel-cell group. Then, once the battery voltage is lowered by $0.15 \pm 0.05V$, it will allow charging again.

The protection circuit also provides over-temperature protection and will prevent the battery from charging at temperatures $\geq 58 \pm 3^{\circ}C$. Then, once the battery temperature has cooled to $\leq 54 \pm 3^{\circ}C$, it will again allow charging.

3.4.3. Over-Discharge Protection

The protection circuit will prevent the battery from being further discharged once any cell voltage reaches $2.4 \pm 0.08V$ or less per parallel-cell-group. Then, once the battery voltage has risen by $0.2 \pm 0.1V$ by charging, it will allow the battery to discharge again.

The protection circuit also provides over-temperature protection and will prevent the battery from discharging at temperatures $\geq 70 \pm 4^{\circ}C$. Then, once the battery temperature has cooled to $\leq 65 \pm 4^{\circ}C$, it will again allow discharging.

3.4.4. Over-Current Protection

The protection circuit will prohibit the discharge of the battery if a short-circuit or an excessive in-rush demand is placed across the battery + / - terminals. Once in the over-current mode, the load will have to be removed to reset the fault condition (automatically reset). There are three levels of over-current protection provided by the protection IC:

- 1) When the discharge current becomes higher than the specified limit ($50A < I_{trip} < 18A$) and the state continues for longer than the delay time ($100\mu S < T_{3delay} < 600\mu S$), the protection circuit will enter the over-current mode and shutdown discharge.
- 2) When the discharge current becomes higher than the specified limit ($18A < I_{2trip} < 50A$) and the state continues for longer than the delay time ($1.5mS < T_{2delay} < 4mS$), the protection circuit will enter the over-current mode and shutdown discharge.
- 3) When the discharge current becomes higher than the specified limit ($9A < I_{1trip} < 18A$) and the state continues for longer than the delay time ($5mS < T_{1delay} < 15mS$), the protection circuit will enter the over-current mode and shutdown discharge.



Specification Number	DS153HD26
Specification Revision	1.0
Prepared By	RAH
Issue date	4/25/08

Battery Specification

The micro-controller circuit also provides continuous over-current protection and will prevent the battery from discharging at currents $\Rightarrow 6.5A \pm 3\%$. Then, at periodic intervals, the battery will re-test the over-current condition, and again allow discharging.

The micro-controller circuit also provides continuous over-current protection and will prevent the battery from charging at currents $\Rightarrow 3.5A \pm 3\%$. Then, at periodic intervals, the battery will re-test the over-current condition, and again allow charging.

3.5. Passive Safety Protection

3.5.1. Overview Of Operation

The battery pack is fitted with additional components to protect it against abusive charge and discharge conditions. These are in addition to the electronic protection.

3.5.2. Thermal Fuse

A Thermal Fuse is fitted in series with the charge/ discharge path to protect the battery from over temperature. This device goes open circuit if the cell case temperature reaches the fuse's temperature rating of $93^{\circ}C$ ($+0^{\circ}C$, $-5^{\circ}C$). The fuse is non-re-settable rendering the battery pack non-functional.

3.5.3. Slow-Blow Current Fuse

A current slow-blow fuse is assembled in series with the battery pack to protect the battery pack against abusive over current over-load. The hold current is rated at 7A for 4 hours (minimum). The fuse is non-re-settable rendering the battery pack non-functional.

3.6. Mechanical Specifications

3.6.1. Weight

Approximately 1.11lbs. (0.506Kg).

3.6.2. Mating Connector

The recommended interconnection mating connector is AMP P/N 5787422-1 or 5787446-1.



Battery Specification

Specification Number	DS153HD26
Specification Revision	1.0
Prepared By	RAH
Issue date	4/25/08

3.6.5. Mechanical Drawing

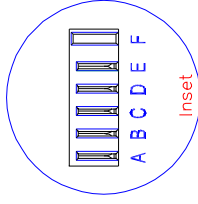

- Terminals
- A - Negative
 - B - Temperature
 - C - Data
 - D - Clock
 - E - Positive
 - F - Key



Specification Number	DS153HD26
Specification Revision	1.0
Prepared By	RAH
Issue date	4/25/08

Battery Specification

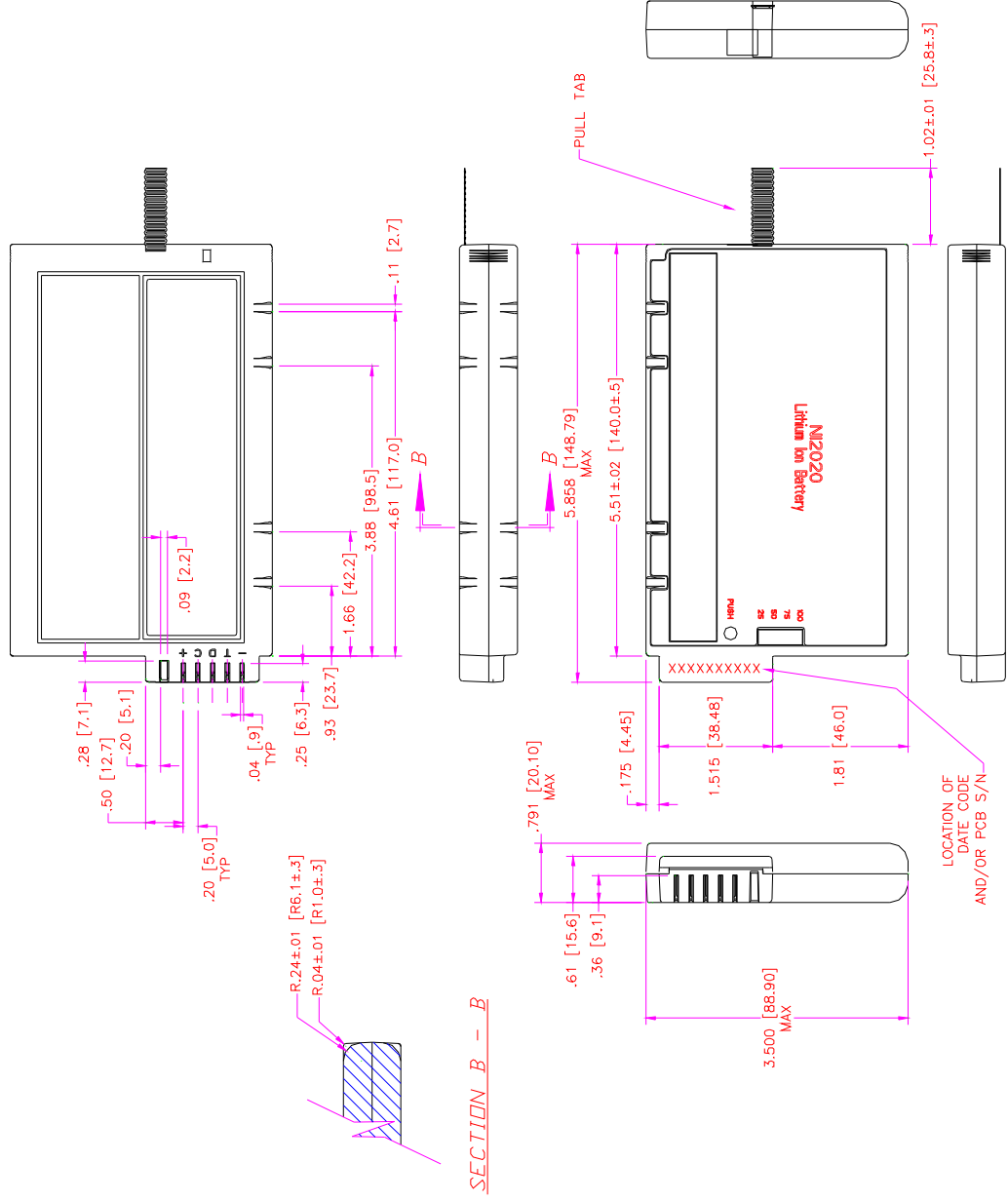



Specification Number	DS153HD26
Specification Revision	1.0
Prepared By	RAH
Issue date	4/25/08

Battery Specification

3.7. Environmental/Safety Specifications

3.7.1. EMC And Safety

The battery complies with the following:

- EMC Directive 89/336/EEC
- Low Voltage Directive 73/23/EEC
- Toxic Chemicals Directive 91/157/EEC
- “RoHS“ Directive 02/95/EC

The battery has been tested in accordance with the UN Manual of tests and Criteria part III subsection 38.3 (ST/SG/AC.10/11/Rev.3) - more commonly known as the UN T1-T8 Transportation tests; and has been found to comply with the stated criteria. [USDOT-E7052]

The battery has the following approvals and the pack will be labeled according:

- FCC
- CE

3.8. Reliability

3.8.1. Life Expectancy

Given normal storage & usage, user can expect the battery to deliver 80% or more of it's initial capacity after 300 charge/discharge cycles where the charge phase is CC/CV 3000mA, 12.6±0.05V and the discharge is 3000mA down to 2.9V/Cell at 25°C.

3.8.2. Warranty

Inspired Energy maintains a high quality standard. All products are warranted against defects in workmanship, material and construction. The warranty period is one (1) year from the date of shipment from Inspired Energy.

3.8.3. Shelf Life

The batteries are shipped from Inspired Energy with between 30% and 50% rated capacity and this provides a minimum of 6 months shelf life, when stored at 25°C. If the storage temperature exceeds 25°C over the 6-month period then the shelf life will be reduced and provisions should be made to recharge the battery periodically.

In order to prevent parasitic drain on the battery, the electronics will go into a shutdown mode at 2.4 ±0.08V/parallel-cell-group. If this should happen, the battery pack will require an initial low charge to activate the electronics prior to the implementation of the normal charge. Any SMBus version 1.0, or higher, compatible charger is capable of providing this initial pre-charge.